

# CIP LIGHTING

A division of Charlotte International Partners Inc.  
1740 First Baxter Crossing, Fort Mill SC 29708 USA  
1-803-396-1439 info@ciplighting.com

# K4

## LED Linear High Bay Light



IP54

SEVEN - YEAR

7

WARRANTY

# 175LM/W



# VEET CB IK10

## HIGH LUMEN LINEAR LED HIGH BAY

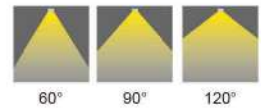
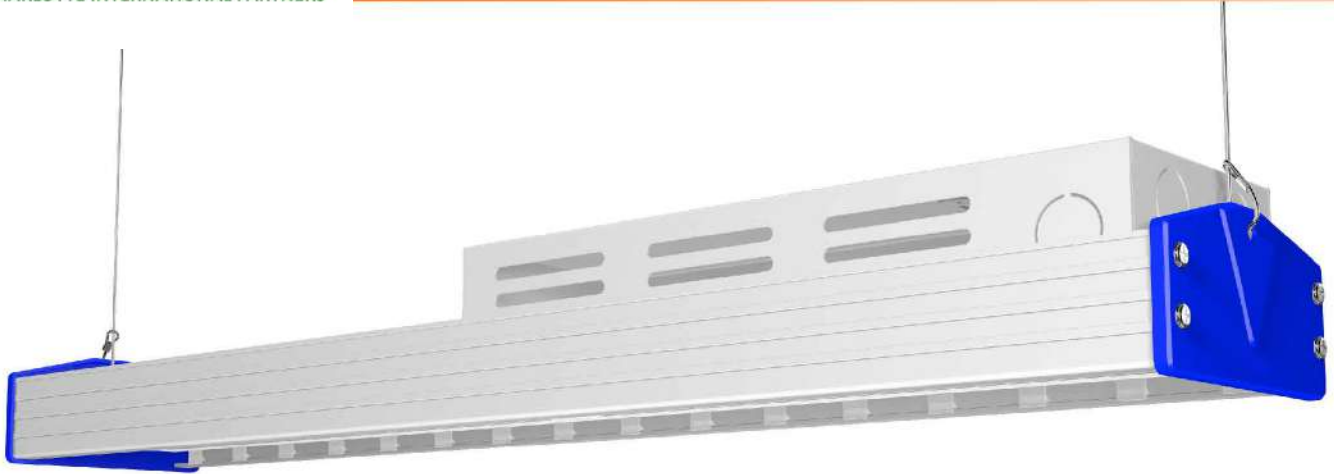

### Product Description

- High luminous efficacy up to 175lm/w
- Separate heat sink for led driver and led chip
- Intelligent lighting: Zigbee wireless control, daylight sensor dimming, microwave sensor dimming, three in one(0-10v,PWM, resistance) dimming available
- Colorful housing can be customized



kWh/1000h

## Features

There is a junction box alongside the fixture for preventing wiring exposed outside. It is safer practice and complied with wiring code

Sandblasting oxidation treatment on heat sink makes fixture body with better abrasion performance and corrosion resistance

Aviation aluminum, customizable colors

3030 SMD LED chip, high lumen  
175LM/W

The lenses are fixed by snap with less screws which makes assembling very conveniently.  
With integral waterproof rubber around lens and rubber plug designed in outlet terminal, IP rating up to IP54  
Three-dimensional diamond light guide technology

# K4 LED Linear High Bay Light

## Accessories

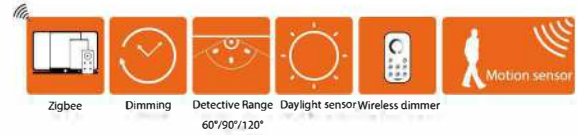

Motion sensor



Daylight sensor



Zigbee wireless control

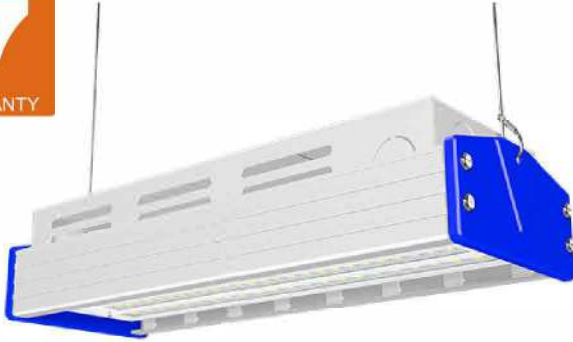

# 50W

## SPECIFICATIONS

### Technical Data

Model Number	HS-HB50W-K4
Power	50W
Luminous Efficacy	175lm/W
Lumen Output	8750lm
LED Quantity	84pcs
Dimension	305*110*54mm
CCT	3000K 4000K 5000K 6000K (Custom Option)
CRI	>80Ra
System Efficiency	≥90%
Beam angle	60°/90°/120°

### Product Dimensions

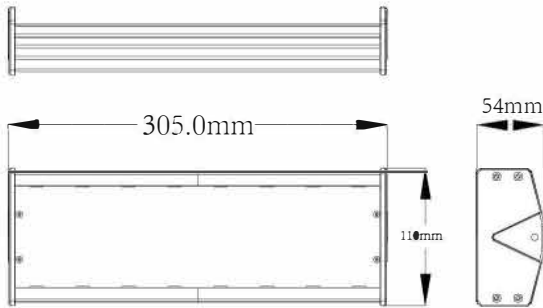

### Photometrics

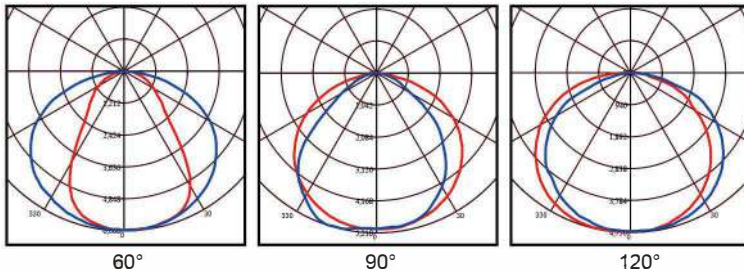

### Electrical Details

Input Voltage	AC100-277V/347V/480V
Power Frequency	50-60Hz
Output Voltage	DC36-48V
Power Efficiency	>92%
Power Factor	≥0.95
Total Harmonic Distortion	≤15%
Dimmable	Yes (Optional)

### Other Details

IP Rating	IP54
Lifespan	100,000+ Hours
Storage Temperature	-20°~65°C
Operating Temperature	-20°~55°C
Luminaire Net Weight	1.4KG
Certification	UL, DLC Premium, SAA, TUV, VEET, CB
Color of housing	Blue+white(customized)

SEVEN - YEAR  
**7**  
WARRANTY



# 100W

## SPECIFICATIONS

### Technical Data

Model Number	HS-HB100W-K4
Power	100W
Luminous Efficacy	175lm/W
Lumen Output	17500lm
LED Quantity	168pcs
Dimension	600*110*54mm
CCT	3000K 4000K 5000K 6000K (Custom Option)
CRI	>80Ra
System Efficiency	≥90%
Beam angle	60°/90°/120°

### Product Dimensions

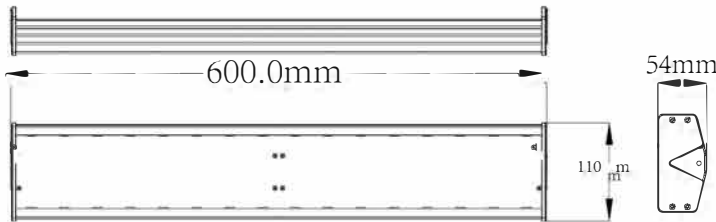

### Photometrics

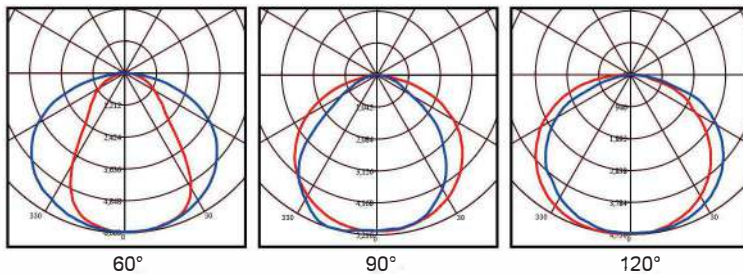

### Electrical Details

Input Voltage	AC100-277V/347V/480V
Power Frequency	50-60Hz
Output Voltage	DC36-48V
Power Efficiency	>92%
Power Factor	≥0.95
Total Harmonic Distortion	≤15%
Dimmable	Yes (Optional)

### Other Details

IP Rating	IP54
Lifespan	100,000+ Hours
Storage Temperature	-20°~65°C
Operating Temperature	-20°~55°C
Luminaire Net Weight	2.5KG
Certification	UL, DLC Premium, SAA, TUV, VEET, CB
Color of housing	Blue+white(customized)

# K4 LED Linear High Bay Light



# 150W

## SPECIFICATIONS



### Technical Data

Model Number	HS-HB150W-K4
Power	150W
Luminous Efficacy	175lm/W
Lumen Output	26250lm
LED Quantity	252pcs
Dimension	895*110*54mm
CCT	3000K 4000K 5000K 6000K (Custom Option)
CRI	>80Ra
System Efficiency	≥90%
Beam angle	60°/90°/120°

### Product Dimensions



### Electrical Details

Input Voltage	AC100-277V/347V/480V
Power Frequency	50-60Hz
Output Voltage	DC36-48V
Power Efficiency	>92%
Power Factor	≥0.95
Total Harmonic Distortion	≤15%
Dimmable	Yes (Optional)

### Photometrics

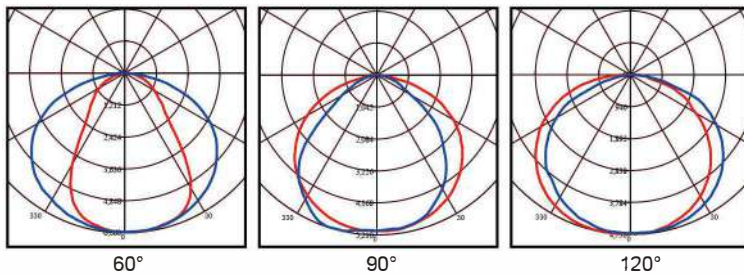

### Other Details

IP Rating	IP54
Lifespan	100,000+ Hours
Storage Temperature	-20°~65°C
Operating Temperature	-20°~55°C
Luminaire Net Weight	3.2KG
Certification	UL,DLC Premium, SAA, TUV, VEET, CB
Color of housing	Blue+white(customized)

SEVEN - YEAR  
**7**  
WARRANTY

# 200W

## SPECIFICATIONS

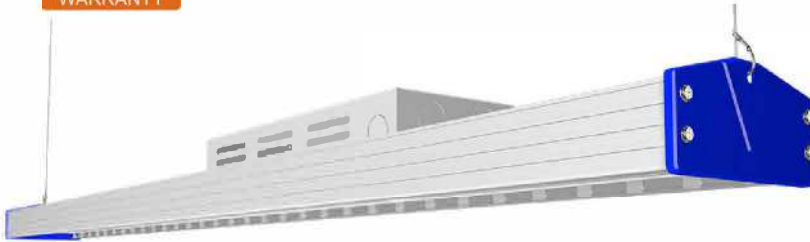

### Technical Data

Model Number	HS-HB200W-K4
Power	200W
Luminous Efficacy	175lm/W
Lumen Output	35000lm
LED Quantity	336pcs
Dimension	1190*110*54mm
CCT	3000K 4000K 5000K 6000K (Custom Option)
CRI	>80Ra
System Efficiency	≥90%
Beam angle	60°/90°/120°

### Product Dimensions

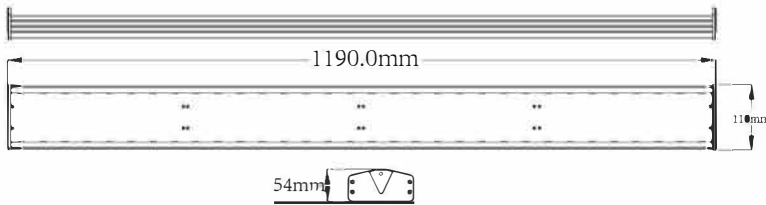

### Electrical Details

Input Voltage	AC100-277V/347V/480V
Power Frequency	50-60Hz
Output Voltage	DC36-48V
Power Efficiency	>92%
Power Factor	≥0.95
Total Harmonic Distortion	≤15%
Dimmable	Yes (Optional)

### Photometrics

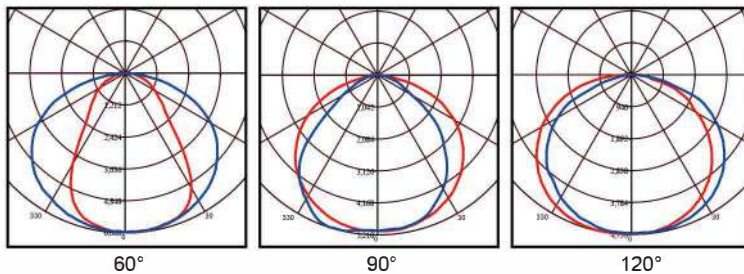

### Other Details

IP Rating	IP54
Lifespan	100,000+ Hours
Storage Temperature	-20°~65°C
Operating Temperature	-20°~55°C
Luminaire Net Weight	3.8KG
Certification	UL, DLC Premium, SAA, TUV, VEET, CB
Color of housing	Blue+white(customized)



SEVEN - YEAR  
**7**  
WARRANTY

# 250W

## SPECIFICATIONS

### Technical Data

Model Number	HS-HB250W-K4
Power	250W
Luminous Efficacy	175lm/W
Lumen Output	43750lm
LED Quantity	336pcs
Dimension	1190*110*54mm
CCT	3000K 4000K 5000K 6000K (Custom Option)
CRI	>80Ra
System Efficiency	≥90%
Beam angle	60°/90°/120°

### Product Dimensions

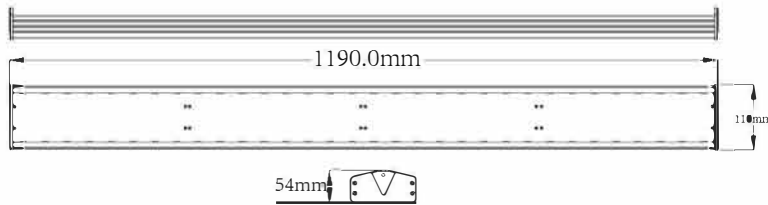

### Electrical Details

Input Voltage	AC100-277V/347V/480V
Power Frequency	50-60Hz
Output Voltage	DC36-48V
Power Efficiency	>92%
Power Factor	≥0.95
Total Harmonic Distortion	≤15%
Dimmable	Yes (Optional)

### Photometrics

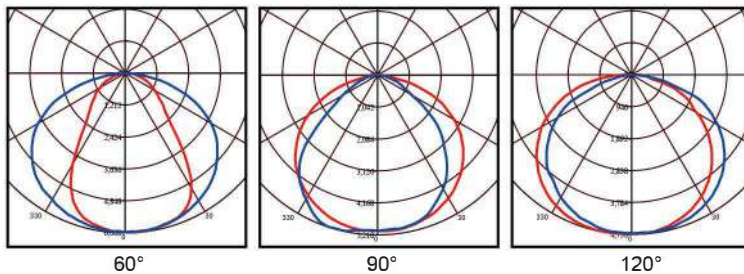

### Other Details

IP Rating	IP54
Lifespan	100,000+ Hours
Storage Temperature	-20°~65°C
Operating Temperature	-20°~55°C
Luminaire Net Weight	4.6KG
Certification	UL, DLC Premium, SAA, TUV, VEET, CB
Color of housing	Blue+white(customized)

# Installation

Suspended mounted

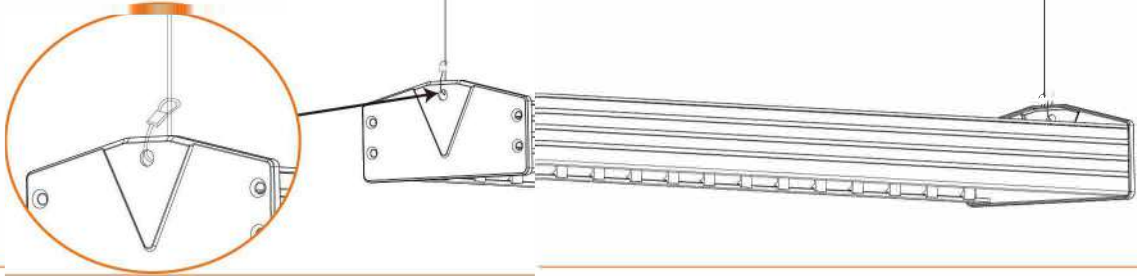

Fixed ceiling mounted

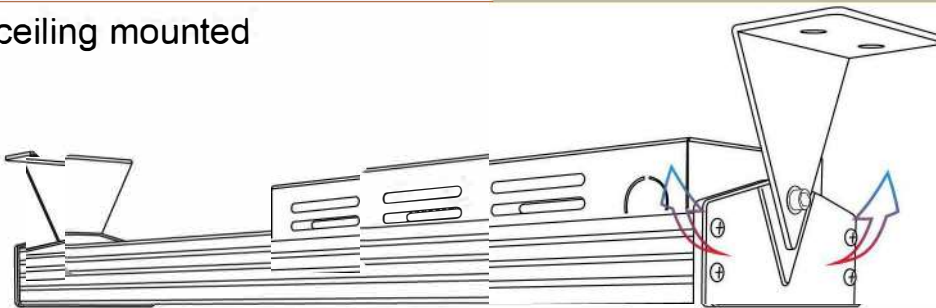

# Application



Widely use in Factory, Workshop, Warehouse, Logistics Center, Exhibition Hall, Stadium, Gas Station,- Supermarket and etc.