

# HB252 | G2 LED High Bay Light

60W / 100W / 150W / 200W / 240W



## Specifications

Part # CIP-HB252-(wattage)-(CCT color)-(beam)-(AC Input)-(options)

Note: We try to keep stock in: 100/150/200/240W, 5000K, 120°, AC100-277V-no/with sensor

<b>Wattage</b>	60W / 100W / 150W / 200W / 240W / Power Switch
<b>LED Chip</b>	SMD 2835, Samsung or other LED Chip
<b>Driver Brand</b>	MEANWELL / SOSEN / ZHIHE or Other Brand
<b>CCT</b>	3000K / 4000K / 5000K / 5700K optional , 3CCT Switch
<b>Light Output</b>	9,300 LM / 15,500 LM / 23,200 LM / 31,000 LM / 37,200 LM
<b>Efficacy</b>	155 LM/W (Can customize higher LM/W if needed)
<b>AC Input Voltage</b>	AC 120~347V/ 120~277V / 277~480V
<b>Light Distribution</b>	60°, 120° (No Reflector Ones)
<b>Mounting Type</b>	Hook Mount , Pendent Mount, U-Bracket
<b>Exclusive Feature(1)</b>	Emergency Battery Kit Available
<b>Exclusive Feature(2)</b>	Motion Sensor Available
<b>Exclusive Feature(3)</b>	Bluetooth Mesh + App for Smart Control Available
<b>Exclusive Feature(4)</b>	3CCT/Power Tunable Optional
<b>Ambient Temperature</b>	-40°C to +45°C(-40°F to +113°F)
<b>Material</b>	Aluminum Alloy
<b>IP Rating</b>	IP65

**Features**



Motion sensor



0-10V Dimming



ADC12 Die casting



CCT Select



Power Select

**3 kinds of Mount: Hook/Ring/U-Bracket**

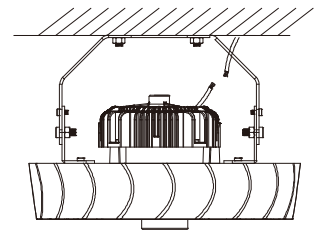
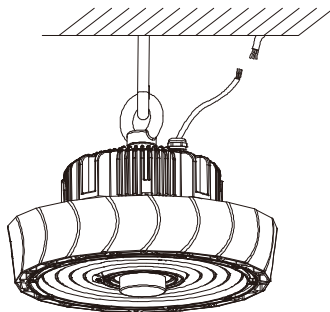
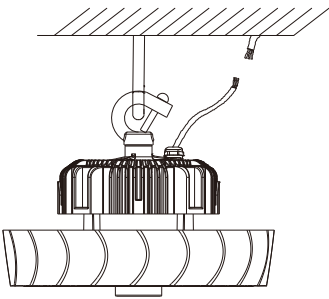

**Motion sensor + Remote Controller : Easy to install**



Motion sensor



Controller



SENSOR 1



SENSOR 2



SENSOR 3

**SENSOR COVERAGE**

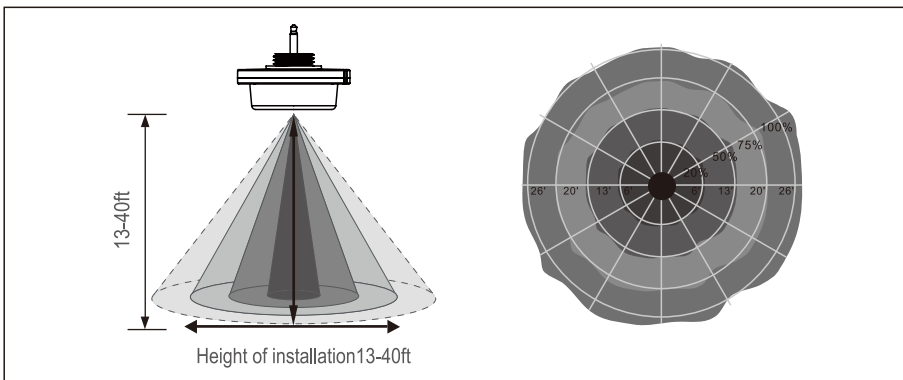

## Different Reflectors Optional



60° Alu Reflector



90° Alu Reflector



120° Alu Reflector



PC Reflector

## Dimensions

### HB252 (60W-150W)

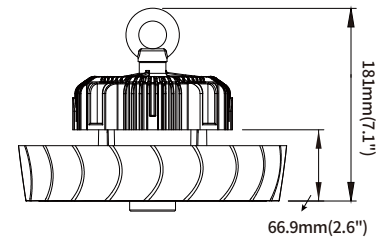
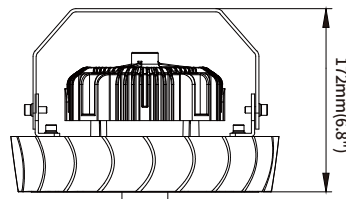
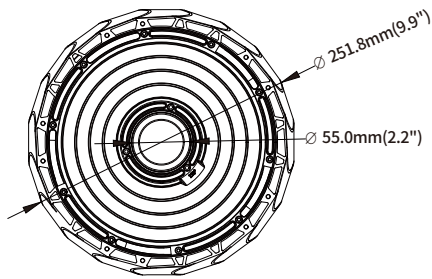

### HB320 (200W-240W)

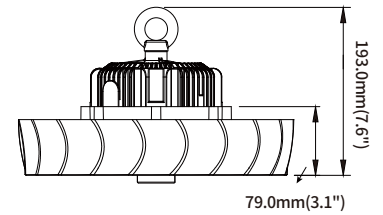
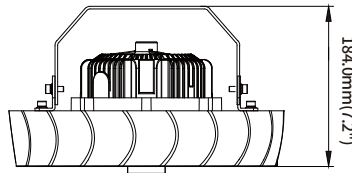
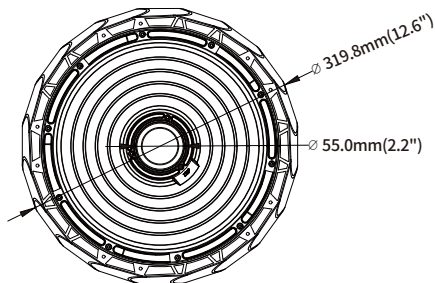

## Light Distribution

### 60 degree

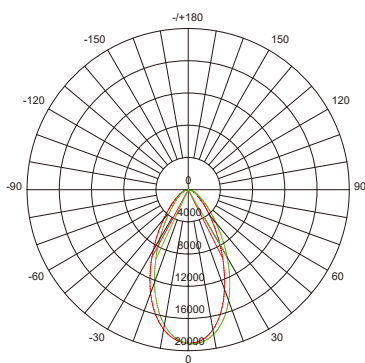

AVERAGE BEAM ANGLE(50%):55.1 DEG

### 120 degree

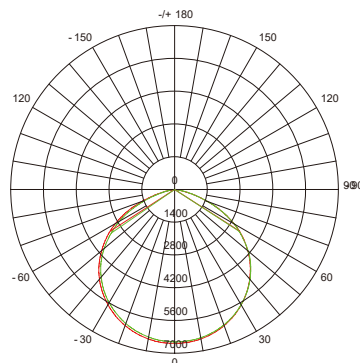

AVERAGE BEAM ANGLE(50%):113.5 DEG





Factory



Basketball Gym



Exhibition Area



Gymnasium



Warehouse



Shopping Mall

## Installation 1

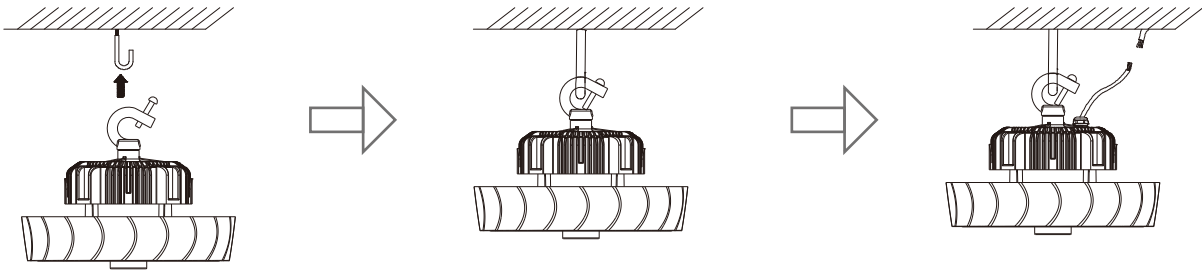

## Installation 2

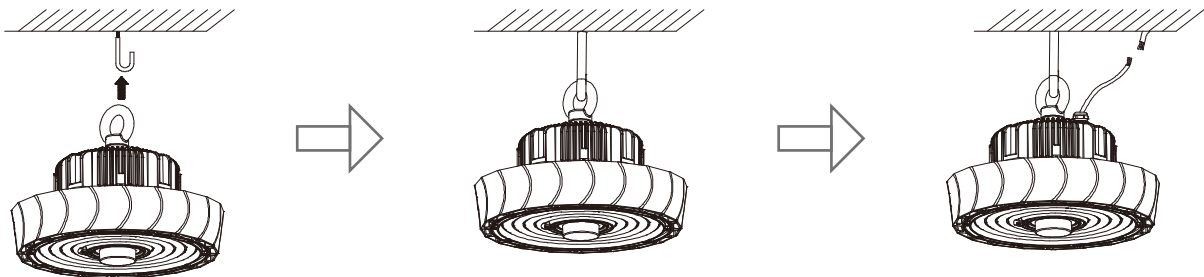

## Installation 3

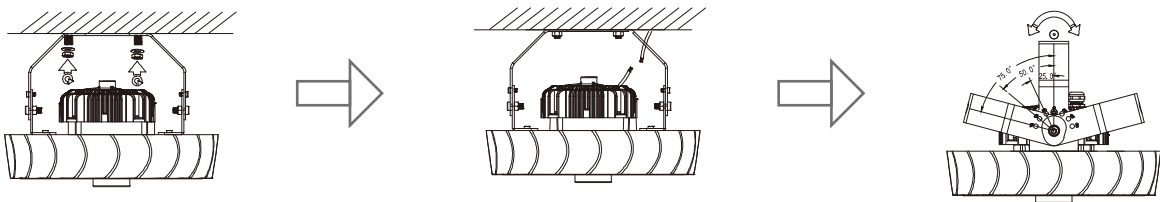

## Reflector Installation

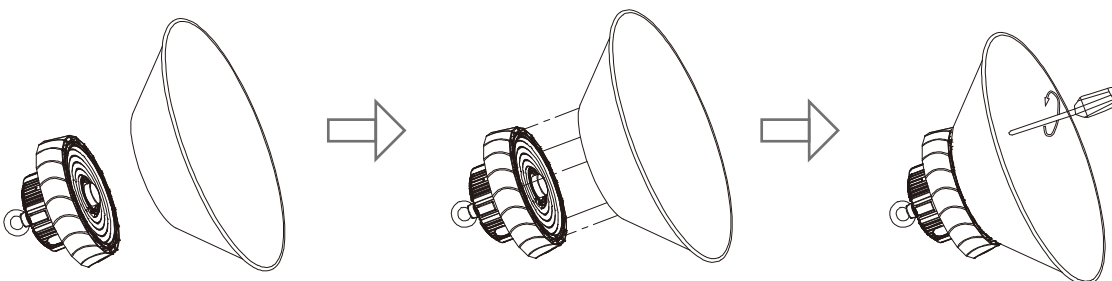

# Packaging information

Wattage	Product Dimension(mm/in)	Carton Box Dimension(mm/in)	N.W (Kg/lb)(1pc)	G.W (Kg/lb)(1ctn)	qty/ctn
60W	252 x 252 x 180 mm 9.92 x 9.92 x 7.09 in	300 x 300 x 190 mm 11.81 x 11.81 x 7.48 in	2.5Kg(5.51lb)	3.2Kg(7.05lb)	1 PCS
100W	252 x 252 x 180 mm 9.92 x 9.92 x 7.09 in	300 x 300 x 190 mm 11.81 x 11.81 x 7.48 in	2.8Kg(6.17lb)	3.5Kg(7.70lb)	1 PCS
150W	252 x 252 x 180 mm 9.92 x 9.92 x 7.09 in	300 x 300 x 190 mm 11.81 x 11.81 x 7.48 in	2.8Kg(6.17lb)	3.5Kg(7.70lb)	1 PCS
200W	"320 x 320 x 193 mm 12.60 x 12.60 x 7.60 in	370 x 370 x 200 mm 14.57 x 14.57 x 7.87 in	4.2Kg(7.72lb)	5.2Kg(11.46lb)	1 PCS
240W	"320 x 320 x 193 mm 12.60 x 12.60 x 7.60 in	370 x 370 x 200 mm 14.57 x 14.57 x 7.87 in	4.2Kg(7.72lb)	5.2Kg(11.46lb)	1 PCS
PC Reflector (60-150W)	480 x 480 x 220 mm 18.90 x 18.90 x 8.66 in	495 x 495 x 400 mm 19.49 x 19.49 x 15.75 in	0.90Kg(1.98lb)	11.0Kg(24.25lb)	10 PCS
60° ALU Reflector (60-150W)	414 x 414 x 176 mm 16.30 x 16.30 x 6.93 in	430 x 430 x 360 mm 16.93 x 16.93 x 14.17 in	0.51Kg(1.12lb)	6.5Kg(14.33lb)	10 PCS
90° ALU Reflector (60-150W)	414 x 414 x 98 mm 16.30 x 16.30 x 3.86 in	430 x 430 x 200 mm 16.93 x 16.93 x 7.87 in	0.45Kg(0.99lb)	6.0Kg(13.23lb)	10 PCS
120° ALU Reflector (60-150W)	384 x 384 x 77 mm 15.12 x 15.12 x 3.03 in	400 x 400 x 150 mm 15.75 x 15.75 x 5.91 in	0.40Kg(0.88lb)	5.5Kg(12.13lb)	10 PCS
PC Reflector (200-240W)	414 x 414 x 180 mm 16.30 x 16.30 x 7.09 in	430 x 430 x 360 mm 16.93 x 16.93 x 14.17 in	0.62Kg(1.37lb)	8.0Kg(17.64lb)	10 PCS
60° ALU Reflector (200-240W)	485 x 485 x 142 mm 19.09 x 19.09 x 5.59 in	500 x 500 x 300 mm 19.69 x 19.69 x 11.81 in	0.30Kg(0.66lb)	4.0Kg(8.82lb)	10 PCS
90° ALU Reflector (200-240W)	435 x 435 x 70 mm 17.13 x 17.13 x 2.76 in	450 x 450 x 150 mm 17.72 x 17.72 x 5.91 in	0.26Kg(0.57lb)	3.5Kg(7.72lb)	10 PCS
120° ALU Reflector (200-240W)	502 x 502 x 100 mm 19.76 x 19.76 x 3.94 in	517 x 517 x 200 mm 20.35 x 20.35 x 7.87 in	0.40Kg(0.88lb)	5.5Kg(12.13lb)	10 PCS

