

# Selectable LED Surface Square Down Lights

Wattage s: 10W , 15W , 20W

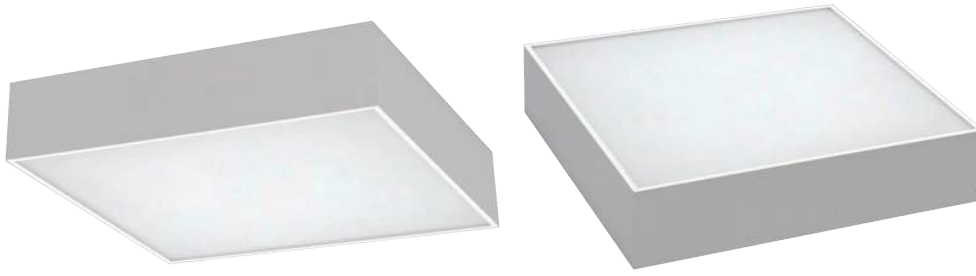

The Selectable LED Surface Square Down Light Series can be widely used for Indoor Excellent for Hallways, Multipurpose Rooms , Underground parking,super market, store and many other applications.

**WATT/CCT**  
SELECTABLE



## Features:

- Lumileds LED, high luminous efficiency and long working life.
- High efficiency LED Driver, the wide range input voltage AC120- 347V.
- Excellent Optics design,greatly improve the light utilization and evenness .
- The 0-10V Dimming type is continuous.
- Motion sensor Control Available ( Optional).

## Packag ing information:

❖CIP-SDW 101520W347-345K-W :

Carton Size: 540 mmX380mmX290 mm  
21.26"X14.97"X11.42"(10Pcs/CTN)

Inside the box:260mmX70mmX275 mm  
10.24"x2.76" x10.83"( 1Pcs/CTN)

SPECIFICATION			
TYPE	CIP-SDW-101520W-347-345K-W		
WATTAGE	10W	15W	20W
LUMEN	1452 lm & 4000K	1927 lm & 4000K	2369 lm & 4000K
EFFICACY	> 120 lm/W		
CCT	3000K,4000K,5000K		
CRI	> 80		
INPUT VOLTAGE	AC120-347V		
LIGHTING ANGLE	108°		
FACTORY SETTINGS	20W & 4000K		
LED TYPE	2835		
PF	> 0.90		
DRIVER EFFICIENCY	> 88%		
PROTECTION LEVEL	Damp		
LIFE TIME	> 50000 hours		
WARRANTY	5 year limited		

# Selectable LED Surface Square Down Lights



Wattage s: 10W , 15W , 20W

Dimension :

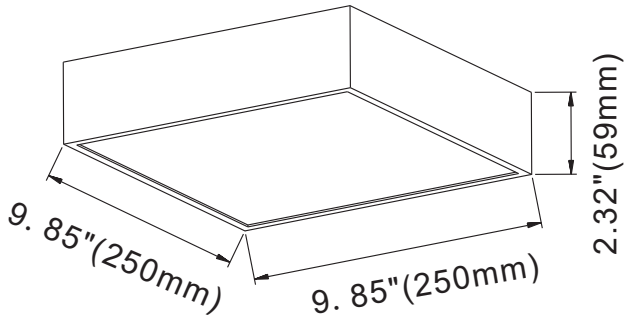

Specifications:

Shell materials: Aluminum & PC .

Net weight : 0.97Kg ( 2.1 lbs)

Finish: White(Standard)

Product Size: 250mmX250mmX59mm  
9.85\"X9.85\"X2.32\"

Control Module:



**WATT/CCT**  
**SELECTABLE**



Selectable CCT

Three position sliding switch  
3000K / 4000K / 5000K



Selectable Power

Three position sliding switch  
10W / 15W / 20W



EMERGENCY BACK-UP (SOLD SEPARATELY)

CONTROL (SOLD SEPARATELY)



EMPK04E27-4W  
Emergency Backup  
Battery LED Driver



ANT- 8A  
Microwave Bi-level Sensor (12V DC)



RC100  
Remote Controller

ORDERING INFORMATION:

EXAMPLE:

CIP-SDW 101520W-347-345K-Z[D,W,B,S]-E[Blank,EC,M,ECM] **Highlighted in what we try to keep in US stock**

CIP	SDW	101520	347	345K	Z	E
COMPANY	PRODUCT	POWER	VOLTAGE	CCT	FINISH	CONTROL
	SDW Surface Square Down Lights	101520 10W/15W 20W	347 AC120-347V	345K 3000K/4000K/5000K	D (Dark Bronze) W (White) B (Black) S (Silver)	EC (Emergency) M (Motion Sensor) ECM (Emergency + Motion Sensor)



CIP LIGHTING  
572 JOHN ROSS PKWY, STE 107, PMB 29  
ROCK HILL, SC 29730

E: INFO@CIPLIGHTING.COM  
T: (803) 766-0243

# Selectable LED Surface Square Down Lights



Wattage s: 10W , 15W , 20W

PHOTOMETRICS :

For complete IES files, please visit our website.

CIP-SDW 101520W347-345K-W (20W&3000K)

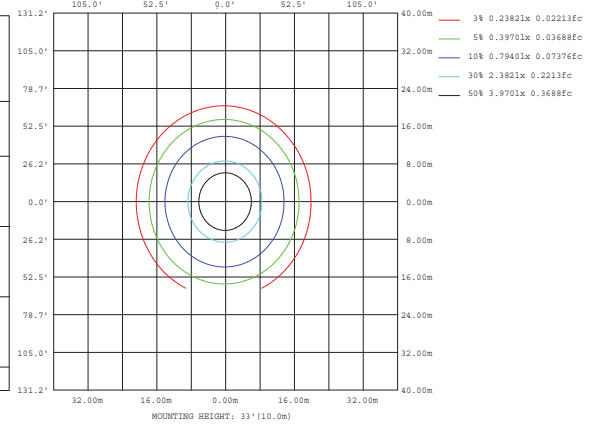
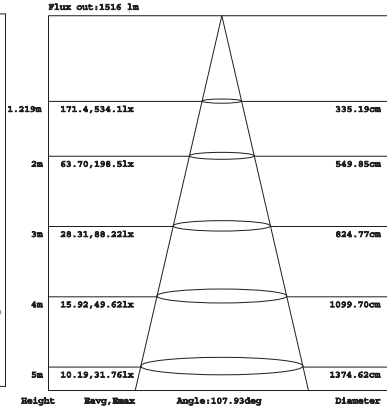
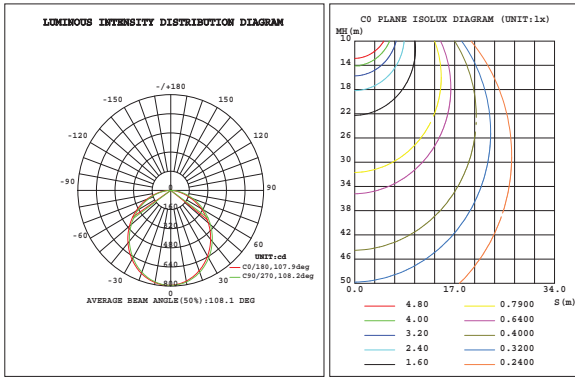

CIP-SDW 101520W347-345K-W (20W&4000K)

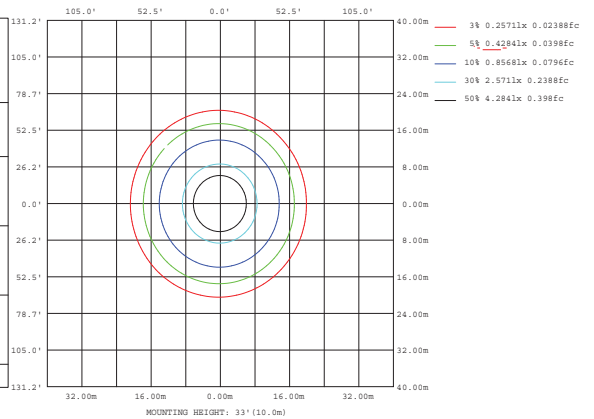
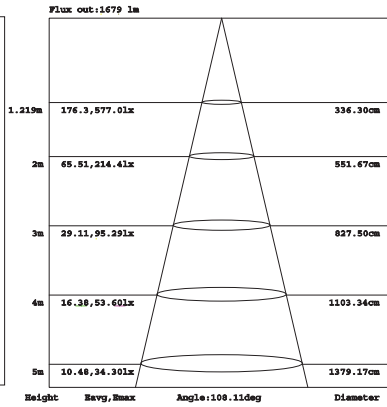
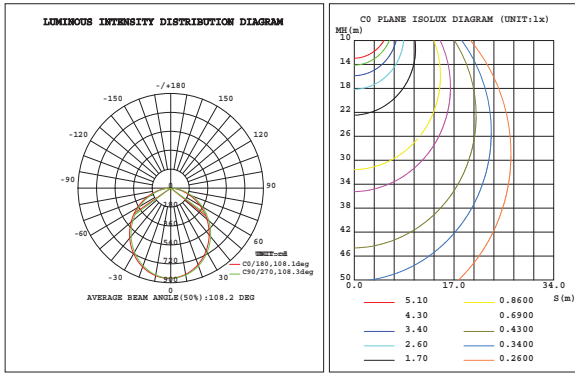

CIP-SDW 101520W347-345K-W (20W&5000K)

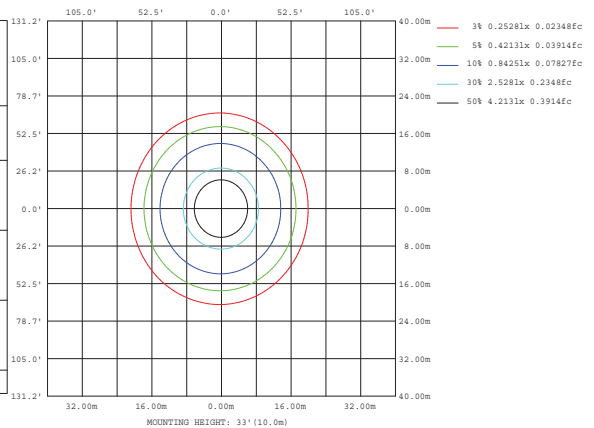
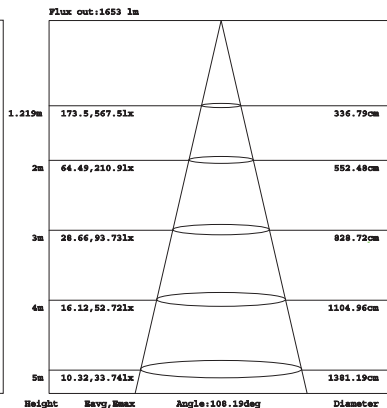
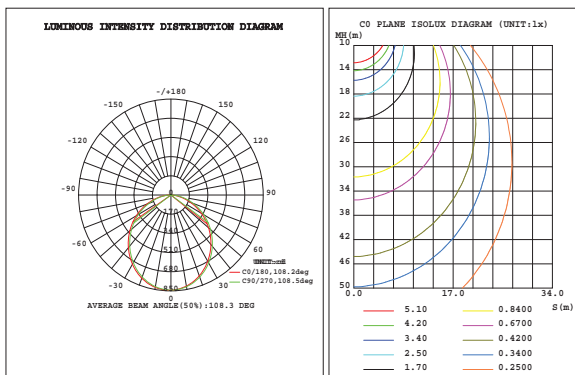

CIP LIGHTING  
572 JOHN ROSS PKWY, STE 107, PMB 29  
ROCK HILL, SC 29730

E: INFO@CIPLIGHTING.COM  
T: (803) 766-0243