



K4

LED Linear High Bay Light

152LM/W

IP54

SEVEN - YEAR

7

WARRANTY



VEET CB IK10

HIGH LUMEN LINEAR LED HIGH BAY

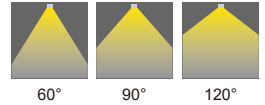
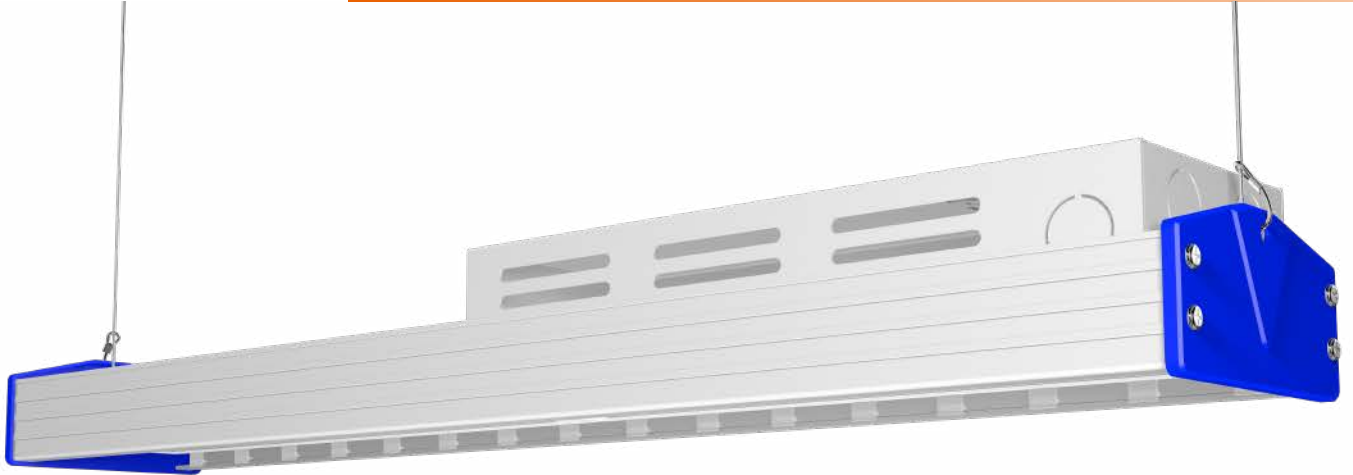

Product Description

- High luminous efficacy up to 152lm/w
- Separate heat sink for led driver and led chip
- Intelligent lighting: Zigbee wireless control, daylight sensor dimming, microwave sensor dimming, three in one(0-10v,PWM, resistance) dimming available
- Colorful housing can be customized

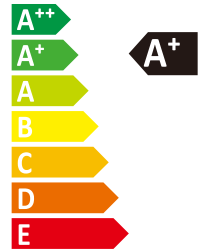
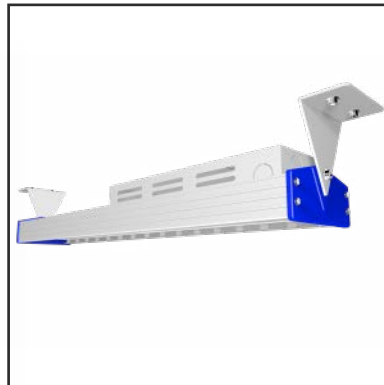
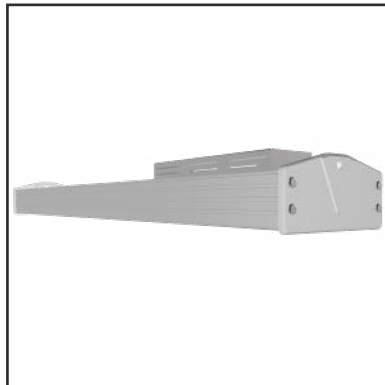
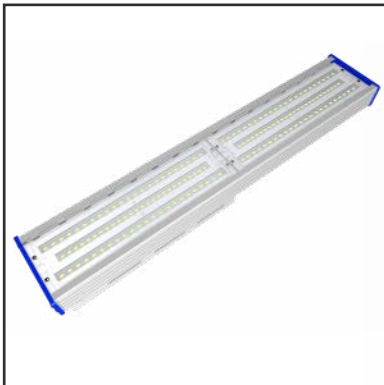

kWh/1000h



K4 LED Linear High Bay Light

Features

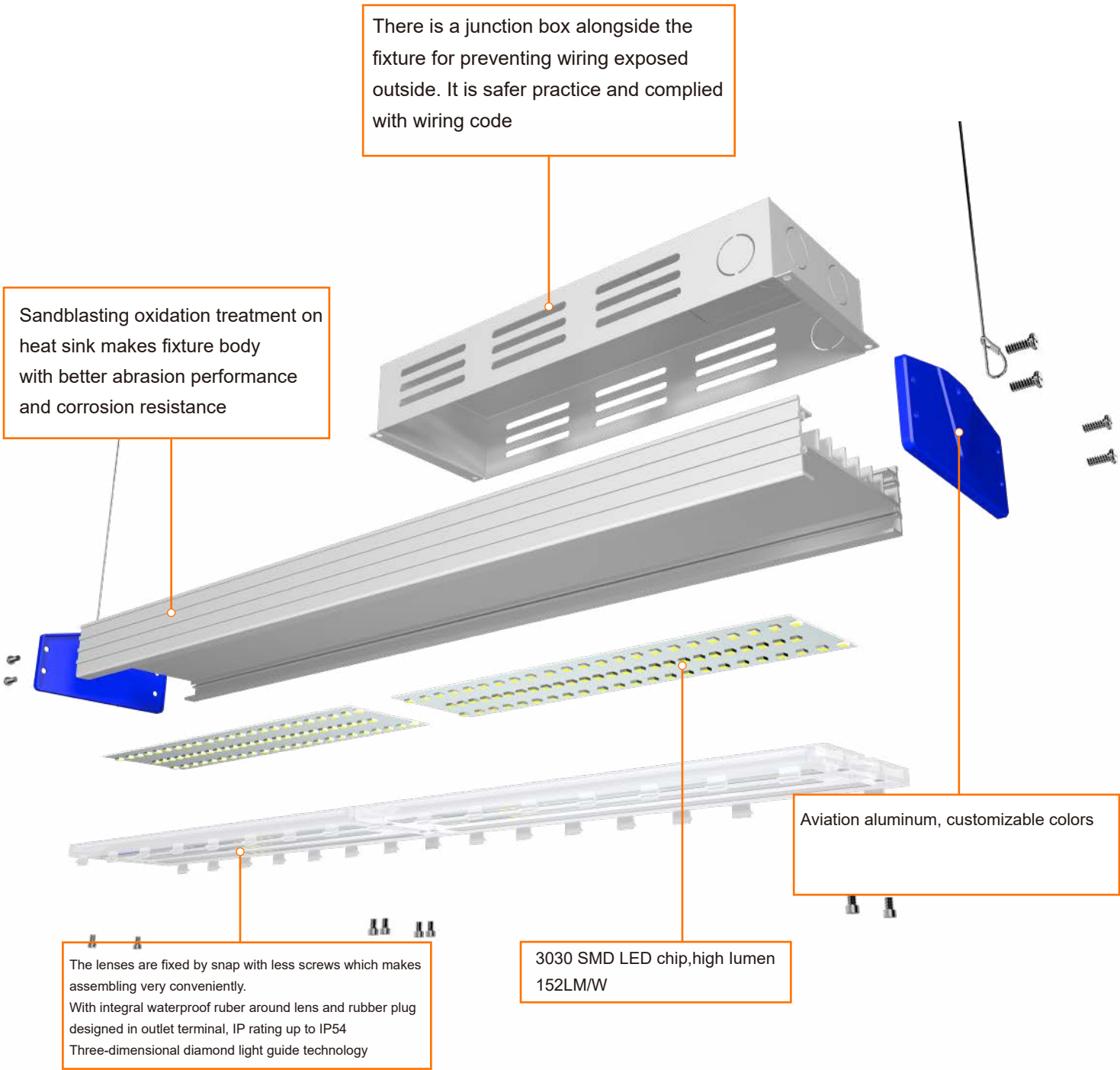

K4 LED Linear High Bay Light

Accessories

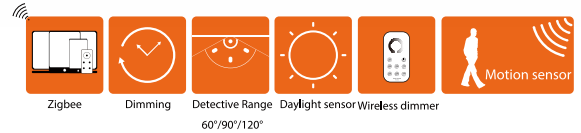

Motion sensor



Daylight sensor



Zigbee wireless control



K4 LED Linear High Bay Light

SEVEN - YEAR
7
WARRANTY

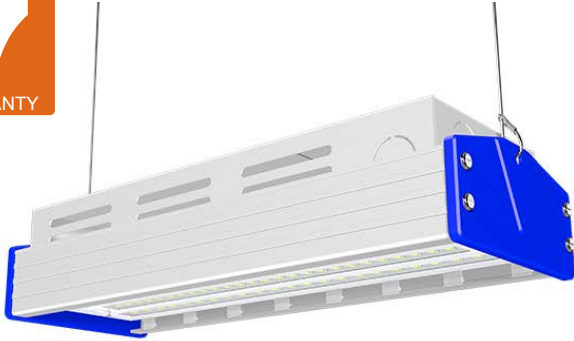

50W

SPECIFICATIONS

Technical Data

Model Number	HB50W-K4
Power	50W
Luminous Efficacy	152lm/W
Lumen Output	7600lm
LED Quantity	84pcs
Dimension	305*110*54mm
CCT	3000K 4000K 5000K 6000K (Custom Option)
CRI	>80Ra
System Efficiency	≥90%
Beam angle	60°/90°/120°

Product Dimensions

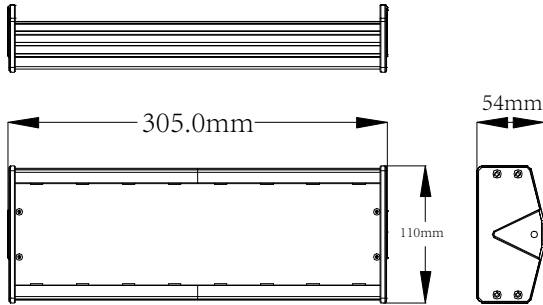

Photometrics

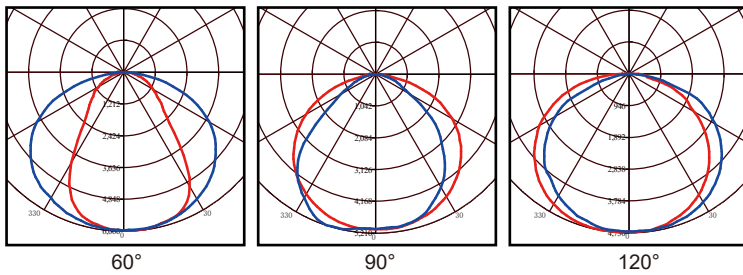

Electrical Details

Input Voltage	AC100-277V/347V/480V
Power Frequency	50-60Hz
Output Voltage	DC36-48V
Power Efficiency	>92%
Power Factor	≥0.95
Total Harmonic Distortion	≤15%
Dimmable	Yes (Optional)

Other Details

IP Rating	IP54
Lifespan	100,000+ Hours
Storage Temperature	-20°~65°C
Operating Temperature	-20°~55°C
Luminaire Net Weight	1.4KG
Certification	UL, DLC Premium, SAA, TUV, VEET, CB
Color of housing	Blue+white(customized)



K4 LED Linear High Bay Light

SEVEN - YEAR
7
WARRANTY



100W

SPECIFICATIONS

Technical Data

Model Number	HB100W-K4
Power	100W
Luminous Efficacy	152lm/W
Lumen Output	15200lm
LED Quantity	168pcs
Dimension	600*110*54mm
CCT	3000K 4000K 5000K 6000K (Custom Option)
CRI	>80Ra
System Efficiency	≥90%
Beam angle	60°/90°/120°

Product Dimensions

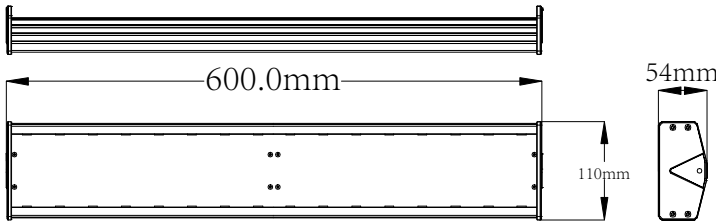

Electrical Details

Input Voltage	AC100-277V/347V/480V
Power Frequency	50-60Hz
Output Voltage	DC36-48V
Power Efficiency	>92%
Power Factor	≥0.95
Total Harmonic Distortion	≤15%
Dimmable	Yes (Optional)

Photometrics

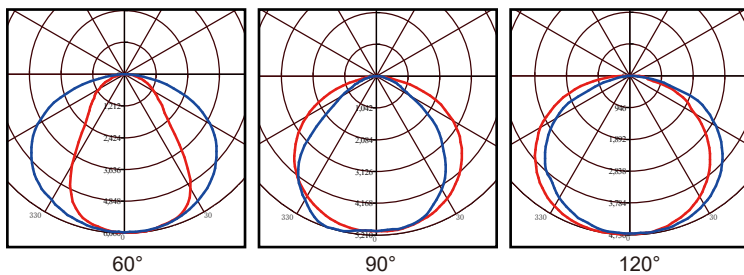

Other Details

IP Rating	IP54
Lifespan	100,000+ Hours
Storage Temperature	-20°~65°C
Operating Temperature	-20°~55°C
Luminaire Net Weight	2.3KG
Certification	UL,DLC Premium,SAA,TUV,VEET,CB
Color of housing	Blue+white(customized)



K4 LED Linear High Bay Light

SEVEN - YEAR
7
WARRANTY



150W

SPECIFICATIONS

Technical Data

Model Number	HB150W-K4
Power	150W
Luminous Efficacy	152lm/W
Lumen Output	22800lm
LED Quantity	252pcs
Dimension	895*110*54mm
CCT	3000K 4000K 5000K 6000K (Custom Option)
CRI	>80Ra
System Efficiency	≥90%
Beam angle	60°/90°/120°

Product Dimensions

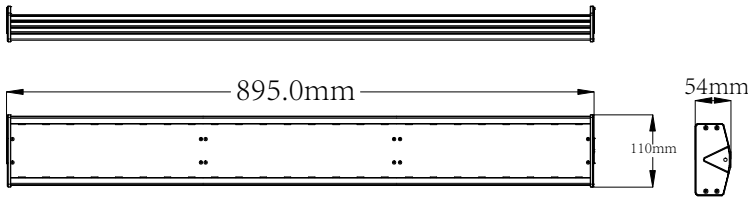

Photometrics

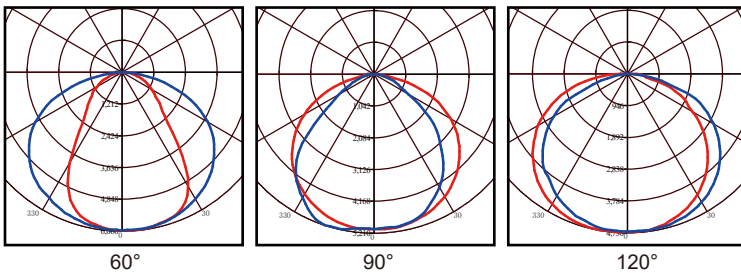

Electrical Details

Input Voltage	AC100-277V/347V/480V
Power Frequency	50-60Hz
Output Voltage	DC36-48V
Power Efficiency	>92%
Power Factor	≥0.95
Total Harmonic Distortion	≤15%
Dimmable	Yes (Optional)

Other Details

IP Rating	IP54
Lifespan	100,000+ Hours
Storage Temperature	-20°~65°C
Operating Temperature	-20°~55°C
Luminaire Net Weight	3.6KG
Certification	UL,DLC Premium,SAA,TUV,VEET,CB
Color of housing	Blue+white(customized)



K4 LED Linear High Bay Light

200W

SPECIFICATIONS

SEVEN - YEAR
7
WARRANTY

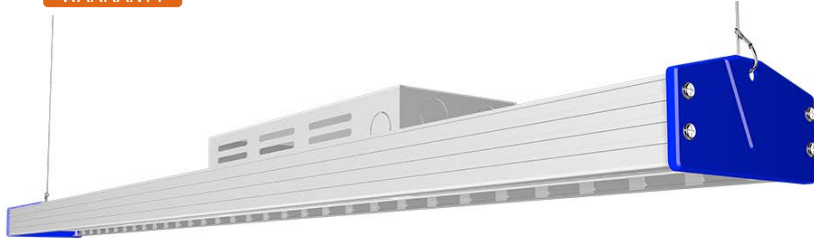

Technical Data

Model Number	HB200W-K4
Power	200W
Luminous Efficacy	152lm/W
Lumen Output	30400lm
LED Quantity	336pcs
Dimension	1190*110*54mm
CCT	3000K 4000K 5000K 6000K (Custom Option)
CRI	>80Ra
System Efficiency	≥90%
Beam angle	60°/90°/120°

Product Dimensions

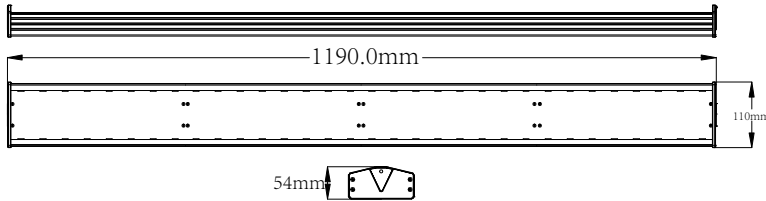

Electrical Details

Input Voltage	AC100-277V/347V/480V
Power Frequency	50-60Hz
Output Voltage	DC36-48V
Power Efficiency	>92%
Power Factor	≥0.95
Total Harmonic Distortion	≤15%
Dimmable	Yes (Optional)

Photometrics

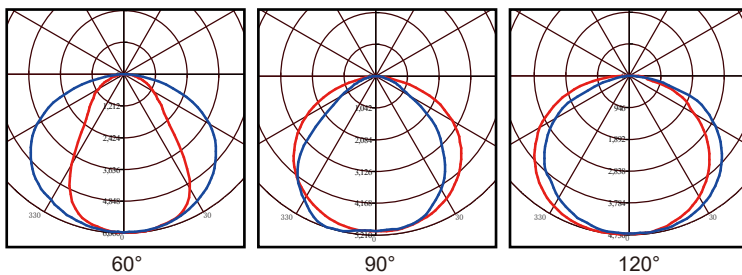

Other Details

IP Rating	IP54
Lifespan	100,000+ Hours
Storage Temperature	-20°~65°C
Operating Temperature	-20°~55°C
Luminaire Net Weight	4.3KG
Certification	UL,DLC Premium,SAA,TUV,VEET,CB
Color of housing	Blue+white(customized)



K4 LED Linear High Bay Light

SEVEN - YEAR
7
WARRANTY

250W

SPECIFICATIONS

Technical Data

Model Number	HB250W-K4
Power	250W
Luminous Efficacy	152lm/W
Lumen Output	38000lm
LED Quantity	336pcs
Dimension	1190*110*54mm
CCT	3000K 4000K 5000K 6000K (Custom Option)
CRI	>80Ra
System Efficiency	≥90%
Beam angle	60°/90°/120°

Product Dimensions

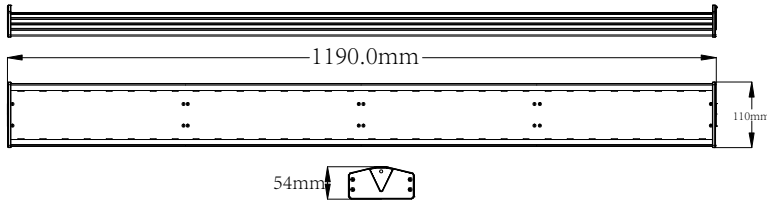

Electrical Details

Input Voltage	AC100-277V/347V/480V
Power Frequency	50-60Hz
Output Voltage	DC36-48V
Power Efficiency	>92%
Power Factor	≥0.95
Total Harmonic Distortion	≤15%
Dimmable	Yes (Optional)

Photometrics

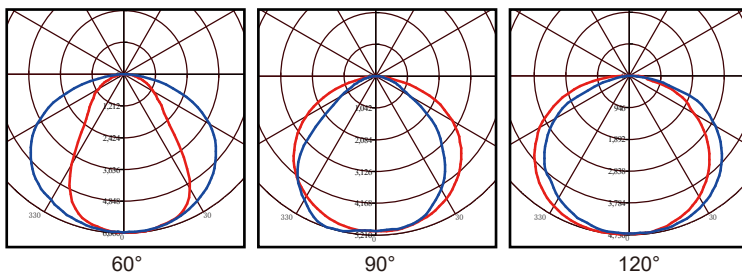

Other Details

IP Rating	IP54
Lifespan	100,000+ Hours
Storage Temperature	-20°~65°C
Operating Temperature	-20°~55°C
Luminaire Net Weight	4.75KG
Certification	UL,DLC Premium,SAA,TUV,VEET,CB
Color of housing	Blue+white(customized)



K4 LED Linear High Bay Light

Installation

Suspended mounted

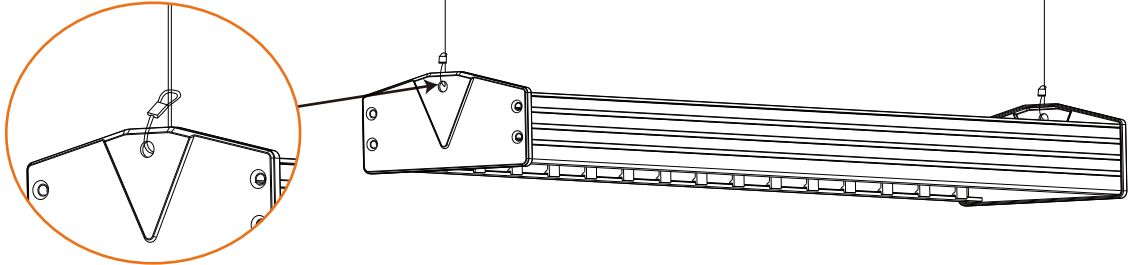

Fixed ceiling mounted

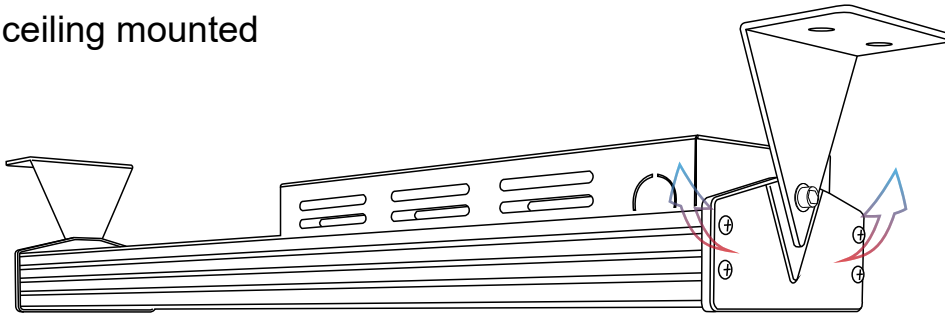

Application



Widely use in Factory, Workshop,
Warehouse, Logistics Center,
Exhibition Hall, Stadium,
Gas Station, Supermarket and etc.

K4 LED Linear High Bay Light

Packing Info

Model No.	N.G(KG)	G.W (KG)	Pcs/carton	Carton Size(CM)
HB50W-K4	1.4	/	4	40*32*28
HB100W-K4	2.3	10.6	4	69*32*28
HB150W-K4	3.6	16	4	100*32*28
HB200W-K4	4.3	19	4	128*32*29
HB250W-K4	4.75	20.7	4	128*32*29