

PSSS

Straight Square Steel Poles, 4", 5"

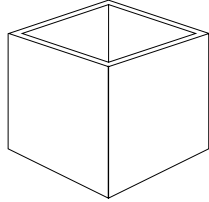

4" and 5" Square

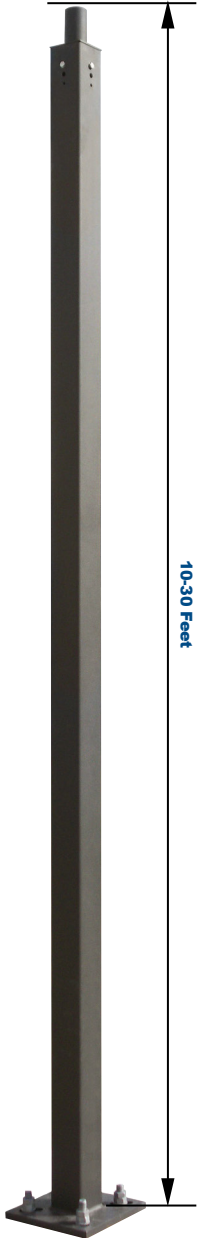
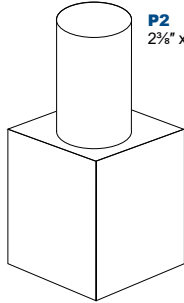

P2
2 3/8" x 4" Tenon

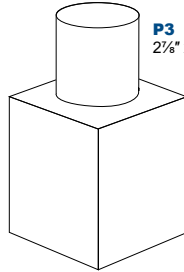

P3
2 1/2" x 3" Tenon

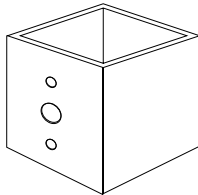

Side Drills:
2 at 180°, 4 at 90°

The LEPG PSSS Series Straight Square Steel poles are built from high strength steel tube and are available side drilled for arm mounted area lighting luminaires or with tenon mounts for flood and post top luminaires. Typical area lighting applications include retail centers, industrial parks, schools and universities, public transit and airports, office buildings and medical facilities. Mounting heights of 10 to 30 feet can be used based on selected luminaire application.

Specifications and Features:

Pole Specifications:

Conforms to ASTM-A 500 Grade B: Minimum Yield Strength of 46,000 PSI. Wall Thickness Available in 11 Gauge (.120") or 7 Gauge (.180").

Finish:

Textured Architectural Bronze Powdercoat Finish, Baked to Ensure Maximum Paint Adhesion, Hardness and Durability.

Anchor Bolts:

Anchor Bolts are Included, Sized Based on Pole Data Charts for the Selected Pole Size.

Hand Hole:

Cast Iron Reinforced Hand Hole and Cover with Ground Screw.

Base Cover:

Poles are Provided With a Two-Piece Formed Steel Base Cover that is Easily Assembled and Fitted Over Pole Base.

Pole Length:

Poles are Available in Standard Lengths as Shown in the Order Matrix. Poles can be Custom Cut to Order. Consult Factory.

Mounting Options:

Standard Length Poles Include 2 3/8" OD Tenon, Side Drilled 4@90 Degrees, UV-Stabilized Polycarbonate Top Cover and Hole Plugs for Unused Drilling Locations.

Cut To Order Poles can be Side Drilled for 2@180 Degrees or 4@90 Degrees, Includes UV-Stabilized Polycarbonate Top Cover and Hole Plugs for Unused Drilling Locations.

Cut To Order Poles May Also Be Ordered With 2 3/8" OD or 2 1/2" OD Tenons for Use With Post Top Decorative Luminaires, Flood/Area Slip Fitter Fixtures, or Any of a Wide Variety of Pole Top Mounting Accessories.

Project Information:

Project Name: _____	Fixture Type: _____
Complete Catalog #: _____	Date: _____
Comments: _____	

Notes:

Specifications subject to change without notice. Rev. 031023

Ordering Guide:

Order Information Example:

PSSS30507ZP2LBC

PSSS	Z				
Model	Height/Shaft/Gauge (Pick One)	Color	Pole Top Mounting	Drill Template	Options
	4" Square 11 Gauge:	5" Square 7 Gauge:			
PSSS=Straight Square Steel Pole	20411=20' 25411=25'	30507=30'	Z=Bronze	D2=Drilled 2 Sides at 180° with Plugs (1) D4=Drilled 4 Sides with Plugs (1) P2=2 1/4" x 4"H Tenon P3=2 1/4" x 3"H Tenon N=No Pole Top Mounting	(Leave Blank)=Poles with P2 Tenon S=Standard Arm/Accessories D=Kitty Hawk Arm KH25 E=Kitty Hawk Arm KH45 C=Custom (Specify) N=No Template
					(Leave Blank)=No Options LAB=Less Anchor Bolts (2) LBC=Less Base Cover (3)

Notes:

- Side Drilled poles include UV-stabilized polycarbonate pole cap.
- All poles include anchor bolts standard, consult dimension table for size based on pole dimensions.
- All poles include square 2-piece bronze base cover.

Pole Data:

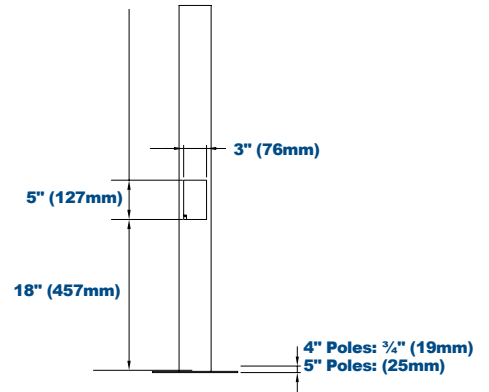
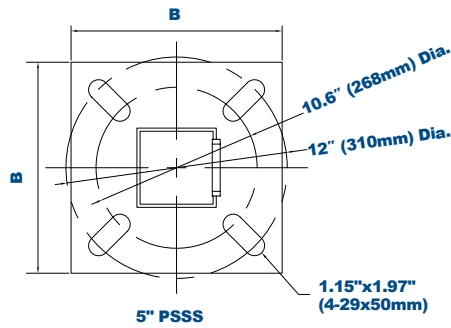
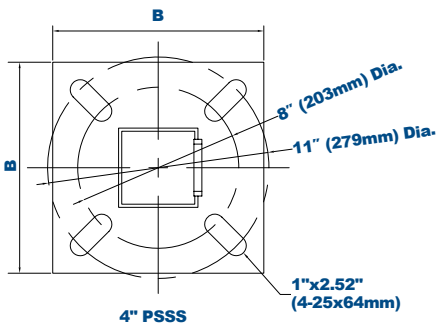

Shaft Base Size	Bolt Circle A	Base Size B	Base Thickness C	Bolt Projection	Anchor Bolt Size
4" PSSS 11 Gauge	8"-11" (203-279mm)	10.5" (266mm)	3/4"	4"	M20 x 27 1/2"
5" PSSS 7 Gauge	10.6"-12" (268-310mm)	11" (280mm)	1"	4"	M22 x 33"

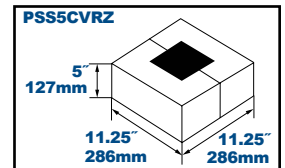
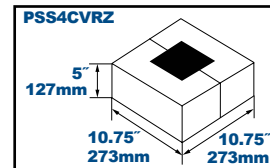

Pole Top Mounting:

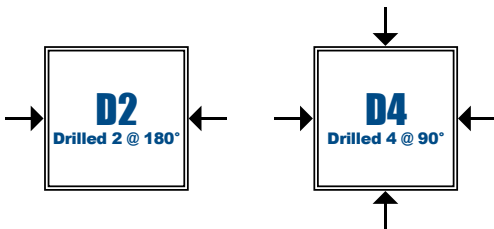

Wind Loading and Dimensional Data:

ASCE7-05 WIND MAP

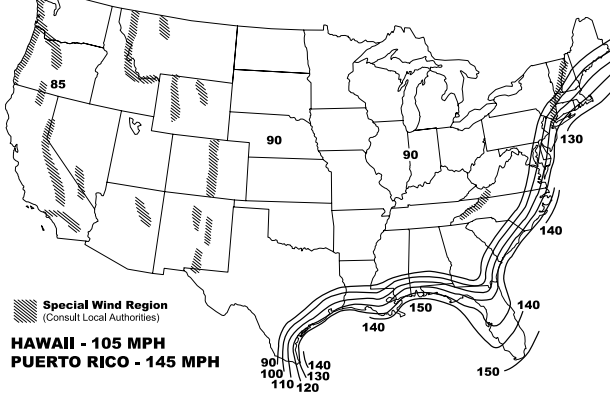

ALASKA REGION WIND MAP

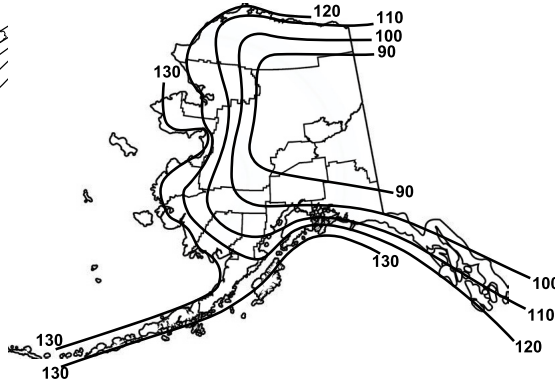

FLORIDA REGION WIND MAP

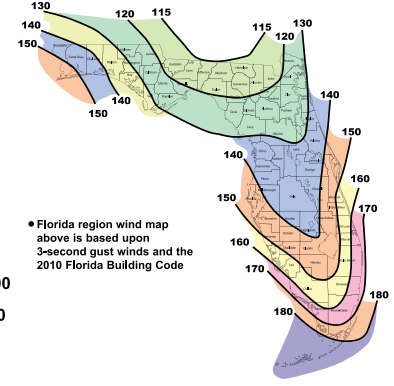

ASCE 7-05 Wind Map EPA Load Rating - 3 Second Gust Wind										
MODEL#	85	90	100	105	110	120	130	140	145	150
PSSS-10411	25	25	25	22.8	20.6	17	14.2	11.9	11	10.1
PSSS-12411	25	25	20	18	16.1	13.2	10.8	8.9	8.1	7.4
PSSS-14411	23.1	20.4	16.1	14.3	12.8	10.2	8.2	6.6	5.9	5.3
PSSS-16411	19	16.7	13	11.5	10.1	7.9	6.2	4.7	4.1	3.6
PSSS-18411	15.6	13.6	10	9	7.8	5.9	4.4	3.1	2.6	2.1
PSSS-20411	12.7	10.9	7.9	6.9	5.9	4.2	2.8	1.7	1.3	0.9
PSSS-25411	7.3	5.9	3.8	2.9	2.1	0.8	NR	NR	NR	NR
PSSS-16507	25	25	25	25	24.8	20.1	16.5	13.6	12.3	11.2
PSSS-18507	25	25	25	22.9	20.4	16.4	13.2	10.7	9.6	8.6
PSSS-20507	25	25	21.3	18.9	16.7	13.2	10.4	8.1	7.2	6.3
PSSS-25507	20.7	17.8	13.3	11.5	9.8	7.2	5	3.3	2.6	1.9
PSSS-30507	13.5	11.3	7.7	6.2	4.9	2.8	1.1	NR	NR	NR

Florida Building Code 2017 EPA Load Rating - 3 Second Gust Wind								
MODEL#	115	120	130	140	150	160	170	180
PSSS-10411	25	25	25	25	21.4	18.4	15.9	13.9
PSSS-12411	25	25	23.6	19.8	16.7	14.2	12.1	10.4
PSSS-14411	25	23.1	19	15.7	13.1	10.9	9.1	7.6
PSSS-16411	20.8	18.7	15.2	12.3	10.1	8.2	6.7	5.4
PSSS-18411	16.8	15	11.9	9.4	7.5	5.9	4.5	3.4
PSSS-20411	13.6	11.9	9.2	7.1	5.3	3.9	2.7	1.7
PSSS-25411	7.4	6.2	4.1	2.5	1.1	NR	NR	NR
PSSS-16507	25	25	25	25	25	21.4	18.2	15.5
PSSS-18507	25	25	25	24.4	20.4	17	14.2	11.9
PSSS-20507	25	25	24.4	19.9	16.3	13.4	11	8.9
PSSS-25507	21.8	19.3	15	11.5	8.8	6.5	4.7	3.1
PSSS-30507	13.7	11.7	8.2	5.5	3.3	1.5	NR	NR

LEPG provides this information as a guide only and assumes no liability for its use. Allowable pole EPA for jobsite wind conditions must be equal to or greater than fixture mount EPA. Responsibility lies with the specifier for the correct pole selection based on A.N.S.I. wind map and job location.

NOTES:

1. Maximum EPA (Effective Projected Area) are based on AASHTO 2013 (90-150MPH) and FBC201/ASCE7-10
2. Consult factory on loading criteria for pole top mounted luminaires and/or brackets.
3. Variations from sizes above are available upon inquiry at the factory.
4. Satisfactory performance of poles is dependent upon the pole being properly attached to a supporting foundation of adequate design.

PSSS

Straight Square Steel Poles, 4", 5"

PB Series

Cast Aluminum Decorative Clamshell Bases

Decorative Clamshell Bases are designed to create a clean decorative look and cover pole base anchoring hardware. Two styles are available in matching finish to coordinate with pole selection.

Specifications and Features:

Clamshell Bases:

Die cast aluminum, Stainless Steel Hardware. PBR1 and PBS1 include sets of inserts that allow use on 4" and 5" square or round poles, and 120mm square or round tall bollards.

Finish:

Textured architectural powdercoat finish, baked to ensure maximum paint adhesion, hardness and durability.

Pole Fit:

Bases are designed to fit poles based on dimensions shown.

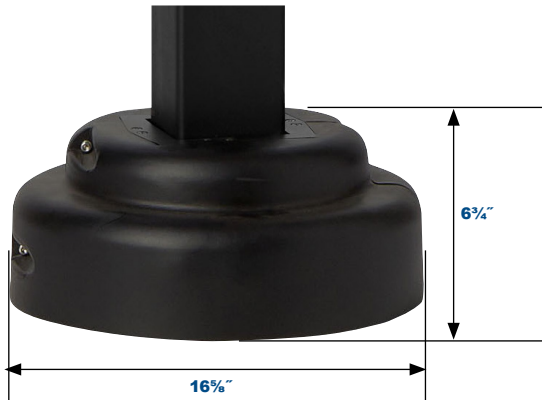

PBR1

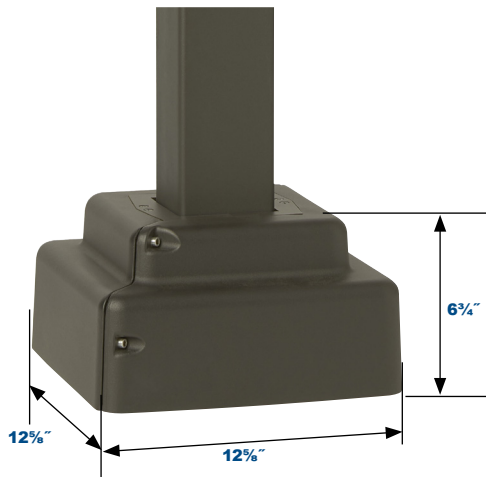

PBS1

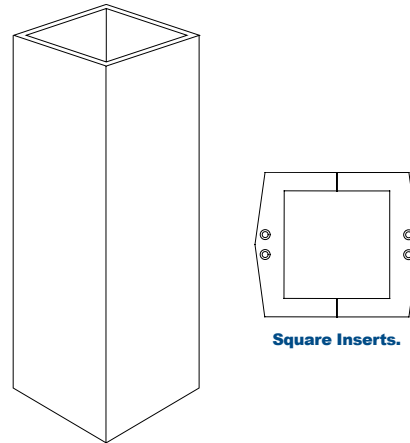

**Smooth Pole
4" Square,
5" Square,
120mm Square
PSSS**

Square Inserts.

Can be used with PSRA, PARS, PARF, PRTS, and PSSS Poles.

Order Information Example:	
Model	Color
PBR1=Round Base PBS1=Square Base	B=Black P=Platinum (PBR1 Only) Z=Bronze C=Custom (Consult Factory)

Project Information:

Project Name: _____ Fixture Type: _____

Complete Catalog #: _____ Date: _____

Comments: _____

Notes:

Specifications subject to change without notice. Rev. 102221

4" Straight Square Steel Pole Mounting Options

Order separately, field installed.

Spoke Brackets and Bullhorns:

Bronze Finish, Spoke Bracket have 7" Arms. Fit 2 3/8" (P2) Tenons.

*Non-stock item. Consult factory for lead time.

All PTSB Spoke Brackets are 9" high from the bottom edge to the top center of the cap

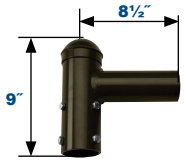

Single Spoke Bracket
PTSB1SZ

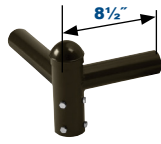

Twin Spoke Bracket,
90° Arms
PTSB290SZ

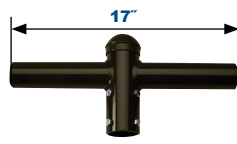

Twin Spoke Bracket,
180° Arms
PTSB2180SZ

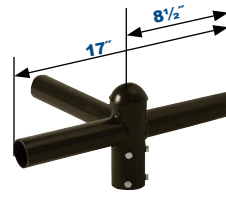

Triple Spoke Bracket,
90° Arms
PTSB390SZ*

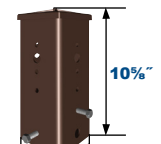

Pole Tenon Adaptor
PTASUNVZ

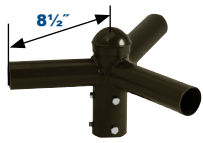

Triple Spoke Bracket,
120° Arms
PTSB3120SZ*

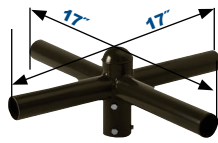

Quad Spoke Bracket,
90° Arms
PTSB490SZ*

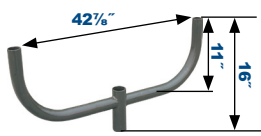

180° Double Bullhorn
PRSD180BHZ
Wt lbs 17, EPA 0.9

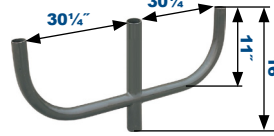

180° Triple Bullhorn
PRSTR180BHZ
Wt lbs 27, EPA 1.5

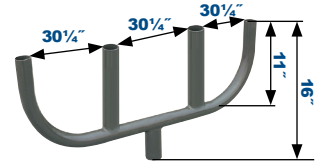

180° Quad Bullhorn
PRSQ180BHZ
Wt lbs 38, EPA 2.2

Vertical Tenon Pole Top Fitters:

4" High Vertical Tenons, Bronze Finish, Fit 2 3/8" (P2) Tenons

Tenon Adaptor:

Fit 2 3/8" (P2) Tenons.

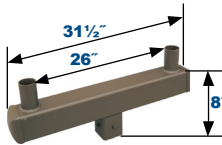

4" Twin Square
Vertical Tenon
PSS4TVTZ
Wt lbs 25, EPA 1.0

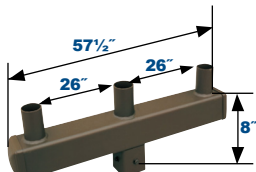

4" Triple Square
Vertical Tenon
PSS4TRVTZ
Wt lbs 40, EPA 1.9

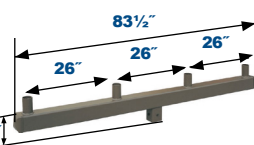

4" 180° Quad Square
Vertical Tenon
PSS4Q180VTZ
Wt lbs 56, EPA 2.7

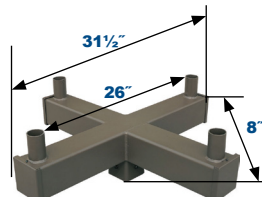

4" 90° Quad Square
Vertical Tenon
PSS4Q90VTZ
Wt lbs 44, EPA 1.1

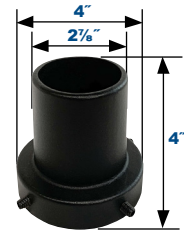

Retrofit Tenon Adaptor for
2 3/8" Tenons
PSRTNB

Vertical Tenon Pole Fitter:

Bronze Finish

Horizontal Tenon Pole Fitters:

4" Horizontal Tenons, Bronze Finish

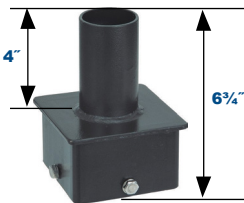

4" Single Square Vertical
Tenon - 2 3/8" Dia.
PSS42SVTZ

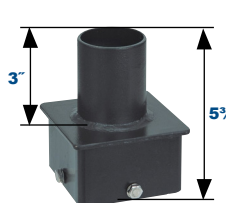

4" Single Square Vertical
Tenon - 2 1/2" Dia.
PSS43SVTZ

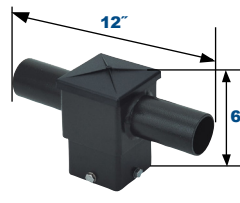

4" 180° Twin Square
Horizontal Tenon
PSS4T180HTZ

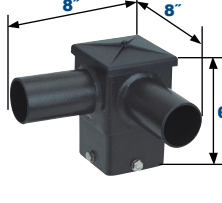

4" 90° Twin Square
Horizontal Tenon
PSS4T90HTZ

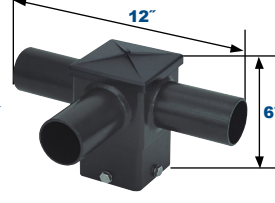

4" 90° Triple Square
Horizontal Tenon
PSS4TR90HTZ

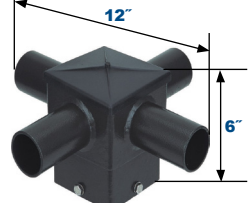

4" 90° Quad Square
Horizontal Tenon
PSS4Q90HTZ

Wall Mounting Bracket:

Bronze Finish

Replacement Parts:

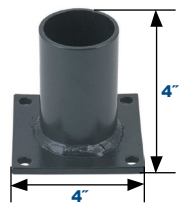

Wall Mount
Bracket
PRSWMBZ

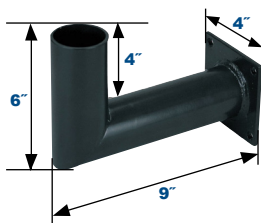

Wall Mount 90°
Bracket
PRSWMB90Z



PSS4CZ



PSS4CVRZ



PSSHHC

Replacement Parts (Order Separately, Field Installed)

PAB34X30 M20 x 27 1/2" Anchor Bolts, Set of 4 for 4" PSSS Poles

PSS4CZ 4" UV-Stabilized Polycarbonate Pole Cap

PSS4CVRZ Base Cover, Bronze Finish

PSSHHC Hand Hole Cover, Bronze Finish

Specifications subject to change without notice. Rev. 060921

5" Straight Square Steel Pole Mounting Options

Order separately, field installed.

Spoke Brackets and Bullhorns:

Bronze Finish, Spoke Bracket have 7" Arms. Fit 2 3/8" (P2) Tenons.

*Non-stock item. Consult factory for lead time.

All PTSB Spoke Brackets are 9" high from the bottom edge to the top center of the cap

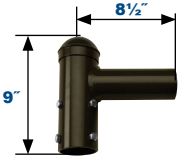

Single Spoke Bracket
PTSB1SZ

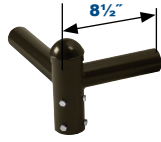

Twin Spoke Bracket,
90° Arms
PTSB290SZ

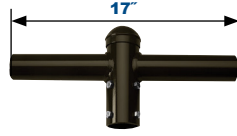

Twin Spoke Bracket,
180° Arms
PTSB2180SZ

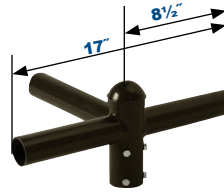

Triple Spoke Bracket,
90° Arms
PTSB390SZ*

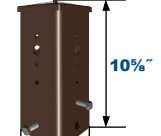

Pole Tenon Adaptor
PTASUNVZ

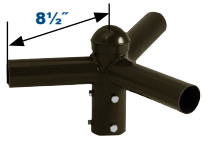

Triple Spoke Bracket,
120° Arms
PTSB3120SZ*

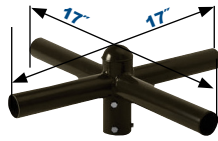

Quad Spoke Bracket,
90° Arms
PTSB490SZ*

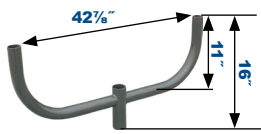

180° Double Bullhorn
PRSD180BHZ
Wt lbs 17, EPA 0.9

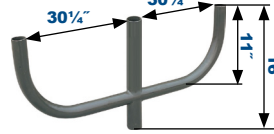

180° Triple Bullhorn
PRSTR180BHZ
Wt lbs 27, EPA 1.5

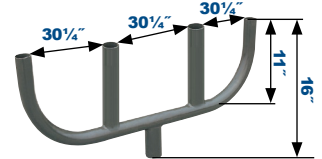

180° Quad Bullhorn
PRSQ180BHZ
Wt lbs 38, EPA 2.2

Vertical Tenon Pole Top Fitters:

4" High Vertical Tenons, Bronze Finish, Fit 2 3/8" (P2) Tenons

Tenon Adaptor:

Fit 2 3/8" (P2) Tenons.

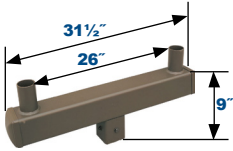

5" Twin Square
Vertical Tenon
PSS5TVTZ
Wt lbs 29.25, EPA 1.0

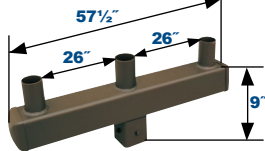

5" Triple Square
Vertical Tenon
PSS5TRVTZ
Wt lbs 46, EPA 1.9

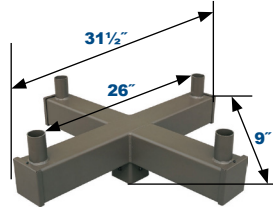

5" 90° Quad Square
Vertical Tenon
PSS5Q90VTZ
Wt lbs 49, EPA 1.1

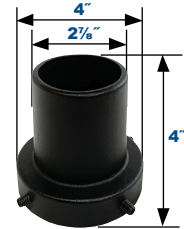

Retrofit Tenon Adaptor for
2 3/8" Tenons
PSRTNB

Vertical Tenon Pole Fitter:

Bronze Finish

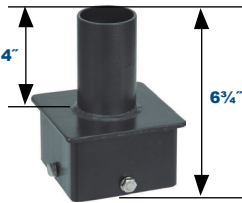

5" Single Square
Vertical Tenon - 2 3/8" Dia.
PSS52SVTZ

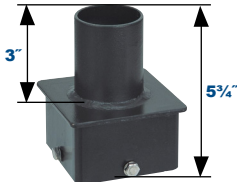

5" Single Square Vertical
Tenon - 2 1/4" Dia.
PSS53SVTZ

Horizontal Tenon Pole Fitters:

4" Horizontal Tenons, Bronze Finish

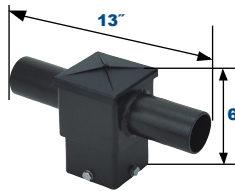

5" 180° Twin Square
Horizontal Tenon
PSS5T180HTZ

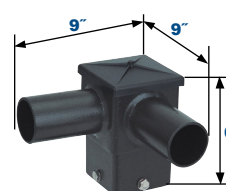

5" 90° Twin Square
Horizontal Tenon
PSS5T90HTZ

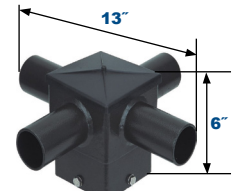

5" 90° Quad Square
Horizontal Tenon
PSS5Q90HTZ

Wall Mounting Bracket:

Bronze Finish

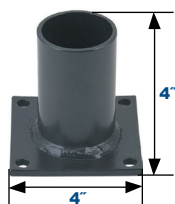

Wall Mount Bracket
PRSWMBZ

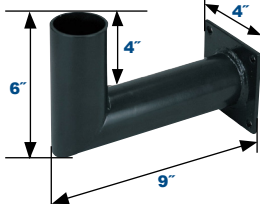

Wall Mount 90° Bracket
PRSWMB90Z
Wt lbs 4.5, EPA 0.3

Replacement Parts:



PSS5CZ



PSS5CVRZ



PSSHHC

Replacement Parts (Order Separately, Field Installed)

PSS5CZ	5" UV-Stabilized Polycarbonate Pole Cap
PSS5CVRZ	Base Cover, Bronze Finish
PAB1X36	M22 x 33" Anchor Bolts, Set of 4
PSSHHC	Hand Hole Cover, Bronze Finish

Specifications subject to change without notice. Rev. 060921