



20mm 12mm | Min Bend | 24V | 5/10/15W/M | DIMMABLE | Horizontal Bend | 120° Beam | IP67 | -25~60°C | RGB | CRI 90+ | CE | UL E464546 | B years

Item No.

CIP-2835-N-P-12x20mm-5/10/15w-120-24-W/R/G/B/A/P
 4040 5/10/15w 96 RGB
 5060 5/10/15w 96 RGBW

- Color Option
- LED Qty
- Power Option
- LED Type

Description

Simply divide into two categories - horizontal & vertical bending
 40mm-300mm bending radius. R/G/B/W/ multiple color
 and digital colors. Standard 24VDC, 12VDC option. The material
 of housing and body are made by silicone material which is special
 designed used in harsh environment. Various shapes (flat, dome or
 rounded surfaces) are available in this series, and they are also
 waterproof (Ip67), ideal for lighting up interior and exterior.

Beam angle

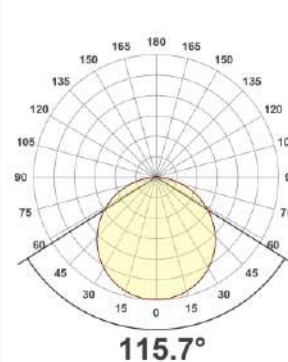

Colour details

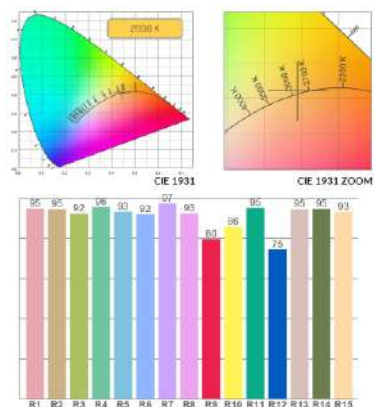

CIP-2835NP-12x20mm10W-12024-30K



LIGHT COLOR MODE

Cool White

6000K

Natural White

4000K

Warm White

2100K/2400K/2700K/3000K



Red



Green



Blue



Amber



tunable
White



RGB+W



RGB

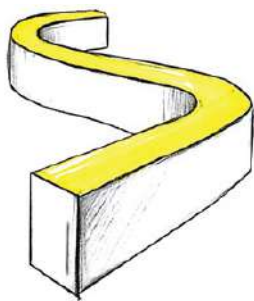

Model:	CIP-2835NP-12x20mm5W-12024-R/G/B/W	Color & Output
Input voltage:	DC24V	<ul style="list-style-type: none"> ● 2100K 131LMM ● 2400K 150LM/M
Power/m:	5W	<ul style="list-style-type: none"> ● 2700K 152LM/M ● 3000K 156LM/M
LED Type:	EPISTAR SMD2835	<ul style="list-style-type: none"> ● 3500K 176LM/M ● 4000K 171LM/M
LED Qty / meter:	120LEDs	<ul style="list-style-type: none"> ● 5000K 170LM/M ● 6000K 168LM/M
Working Mode:	PWM CV/CC	<ul style="list-style-type: none"> ● Red 73LM/M ● Green 198LM/M
Max Length:	CV 10m; CC 27m	<ul style="list-style-type: none"> ● Blue 35LM/M ● Amber 15LM/M
Cut Length:	50mm	<ul style="list-style-type: none"> ● Pink 75LM/M

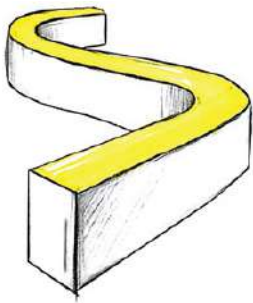

Model: CIP-2835NP-12x20mm10W-12024-R/G/B/W/A/P		Color & Output
Input voltage:	DC24V	<ul style="list-style-type: none"> ● 2100K 285LM/M ● 2400K 293LM/M
Power/m:	10W	<ul style="list-style-type: none"> ● 2700K 303LM/M ● 3000K 307LM/M
LED Type:	EPISTAR SMD2835	<ul style="list-style-type: none"> ● 3500K 345LM/M ● 4000K 335LM/M
LED Qty / meter:	120LEDs	<ul style="list-style-type: none"> ● 5000K 330LM/M ● 6000K 328LM/M
Working Mode:	PWM CV/CC	<ul style="list-style-type: none"> ● Red 155LM/M ● Green 372LM/M
Max Length:	CV 10m; CC 17m	<ul style="list-style-type: none"> ● Blue 70LM/M ● Amber 30LM/M
Cut Length:	50mm	<ul style="list-style-type: none"> ● Pink 148LM/M

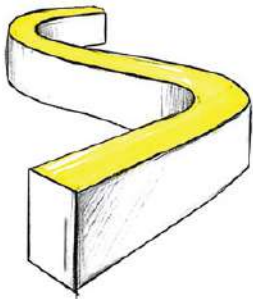

Model: CIP-2835NP-12x20mm15W-12024-R/G/B/W/A/P		Color & Output
Input voltage:	DC24V	<ul style="list-style-type: none"> ● 2100K 360LM/M ● 2400K 410LM/M
Power/m:	15W	<ul style="list-style-type: none"> ● 2700K 430LM/M ● 3000K 432LM/M
LED Type:	EPISTAR SMD2835	<ul style="list-style-type: none"> ● 3500K 475LM/M ● 4000K 470LM/M
LED Qty / meter:	120LEDs	<ul style="list-style-type: none"> ● 5000K 461LM/M ● 6000K 465LM/M
Working Mode:	PWM CV/CC	<ul style="list-style-type: none"> ● Red 204LM/M ● Green 473LM/M
Max Length:	CV 10m; CC 14m	<ul style="list-style-type: none"> ● Blue 93LM/M ● Amber 40LM/M
Cut Length:	50mm	<ul style="list-style-type: none"> ● Pink 199LM/M

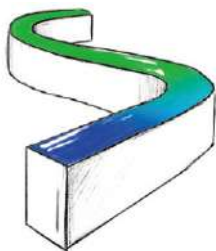

Model: CIP-4040NP-12x20mm5W-9624-RGB		Color & Output
Input voltage:	DC24V	● RGB 26.5LM/M
Power/m:	5W	● RGB 75.3LM/M
LED Type:	SMD4040	● RGB 15.6LM/M
LED Qty / meter:	96LEDs	● RGB 86.1LM/M
Working Mode:	PWM	
Max Length:	CV 5m	
Cut Length:	62.5mm	

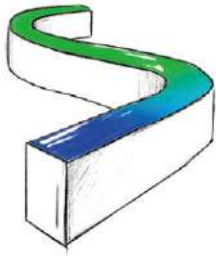



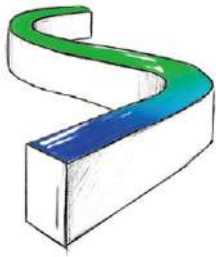

Model:	CIP-4040NP-12x20mm10W-9624-RGB	Color & Output
Input voltage:	DC24V	RGB 35.8LM/M
Power/m:	10W	RGB 107.2LM/M
LED Type:	SMD4040	RGB 22.1LM/M
LED Qty / meter:	96LEDs	RGB 160.2LM/M
Working Mode:	PWM	
Max Length:	CV 5m	
Cut Length:	62.5mm	

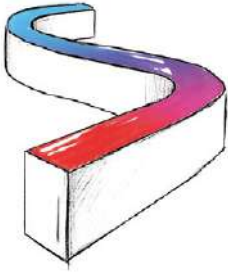





Model:	CIP-4040NP-12x20mm15W-9624-RGB	Color & Output
Input voltage:	DC24V	RGB 50LM/M
Power/m:	15W	RGB 120.8LM/M
LED Type:	SMD4040	RGB 25LM/M
LED Qty / meter:	96LEDs	RGB 230LM
Working Mode:	PWM	
Max Length:	CV 5m	
Cut Length:	62.5mm	

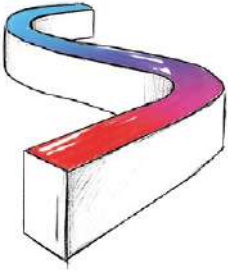





Model:	CIP-5060NP-12x20mm5W-9624-RGBW	Color & Output
Input voltage:	DC24V	 RGB 18LM/M
Power/m:	5W	 RGB 75LM/M
LED Type:	SMD5060	 RGB 18LM/M
LED Qty / meter:	96LEDs	 RGBW 74LM/M
Working Mode:	PWM	 RGBW 190LM/M
Max Length:	CV 5m	
Cut Length:	62.5mm	

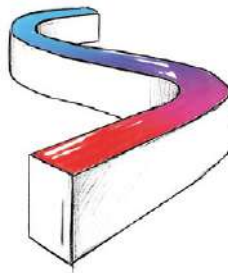

Model:	CIP-5060NP-12x20mm10W-9624-RGBW	Color & Output
Input voltage:	DC24V	 RGB 32LM/M
Power/m:	10W	 RGB 143LM/M
LED Type:	SMD5060	 RGB 34LM/M
LED Qty / meter:	96LEDs	 RGBW 158LM/M
Working Mode:	PWM	 RGBW 366LM/M
Max Length:	CV 5m	
Cut Length:	62.5mm	



Model:	CIP-5060NP-12x20mm15W-9624-RGBW	Color & Output
Input voltage:	DC24V	 RGB 53LM/M
Power/m:	15W	 RGB 166LM/M
LED Type:	SMD5060	 RGB 45LM/M
LED Qty / meter:	96LEDs	 RGBW 210LM/M
Working Mode:	PWM	 RGBW 496LM/M
Max Length:	CV 5m	
Cut Length:	62.5mm	



ACCESSORIES (CONNECTORS)



Front cable enter

Side cable enter

Bottom cable enter

-F

-S

-B

PROFILES (FIXTURES)

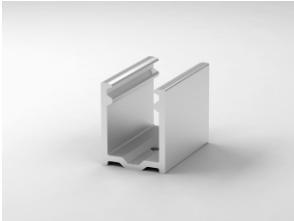

Stainless steel clips
20x12.7x18.7mm

-SS



Aluminimu profile
1000x14.4x21.4mm

-AL



Flexible profile

-FLEX (MOQ)



Suspension wire

-SUS



END CAP

-EC

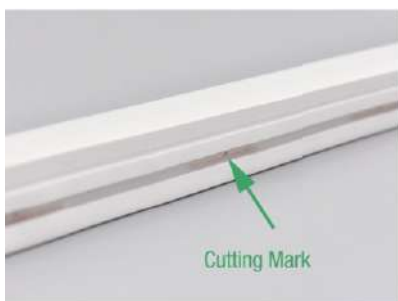

The bottom of LED strip has transparent window, the black marker is the cutting position

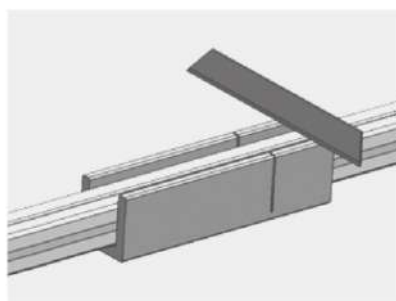

Use a cutting jig, vertical cutting precisely in the exact cutting position of led strip

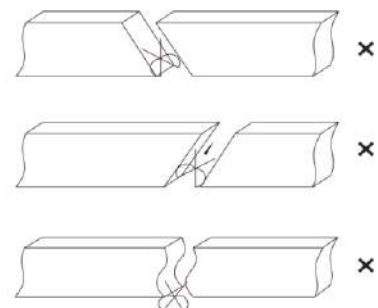

Please don't be free to cut and cut into an oblique angle or cambered section

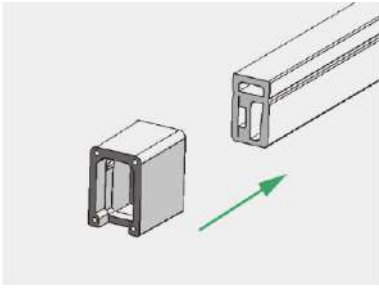

Insert the shell into the strip, insert into the limit

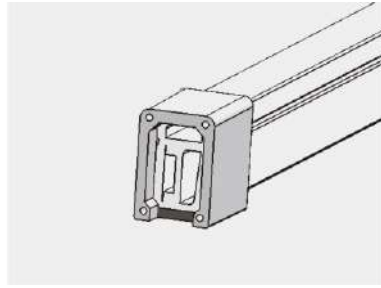

Its window is at the bottom of the LED strip

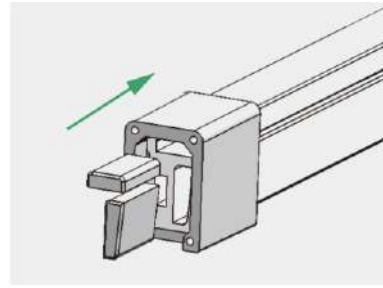

Stuff the plug into the holes corresponding of led strip

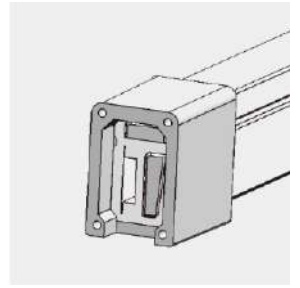

Effect diagram of the finished assembly

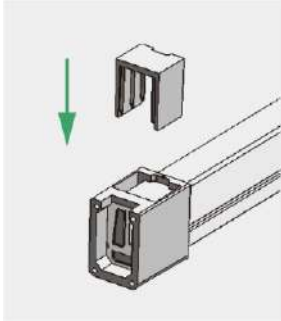

Insert the stopper into the PC shell

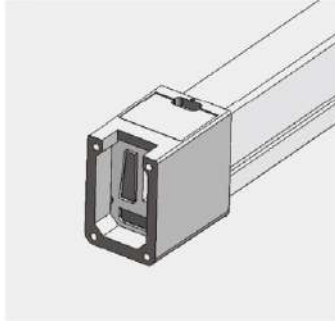

Effect diagram of the stopper assembly completed

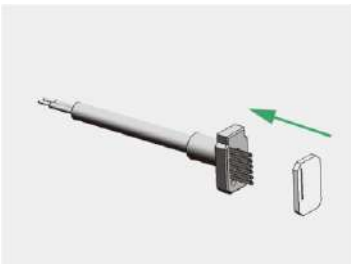

Put the water proof washer into the plug



Effect diagram of the waterproof washer assembly completed

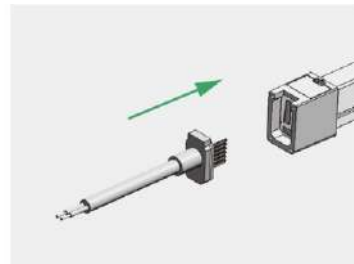

Insert the plug with the washer into the led strip. and the pin insert between FPC and transparent PET

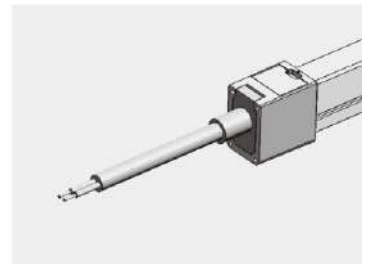

Effect diagram of the plug finished assembly completed

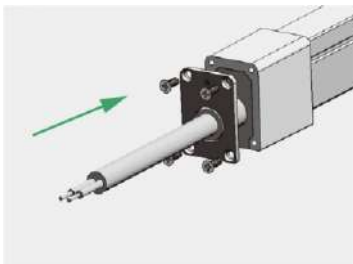

Fix the hard ware on Shell with screws, close to the shell, completed assembly

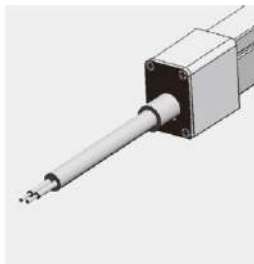

Effect diagram of the metal plate assembly completed

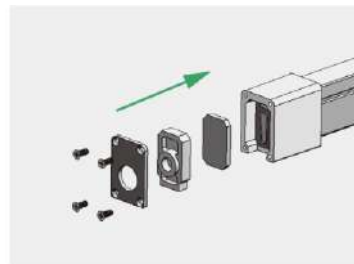

End cap's installation diagram

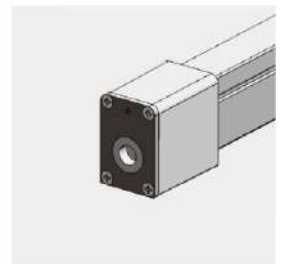

Effect diagram of the metal plate assembly completed