

INTRODUCTION

FEATURES

- Safety Voltage Tracking Slot DC24V or DC48V
- Free Combination of Multiple LED Modules
- Magnetic Suction Easy Fast Installation
- Long Lifespan Design >50,000hours
- Working Ambient Temperature: -15°C~+40°C

CONTENTS

- Magnet Track System
- LED Linear Floodlight
- LED Linear Downlight
- LED Spotlight
- LED Pendant Light

STANDARDS

- Designed and Manufactured to Comply with CE/RoHS/EMF/TUV/SAA/Erp/cETL/FCC
- IP20 Protection, Class III Electric

OPTION

Housing Color Finish: (Painted Colors by RAL#)

MATT WHITE [HMWT] **MATT BLACK** [HMBK]

W20 MAGNETIC TRACK LIGHTING SYSTEM

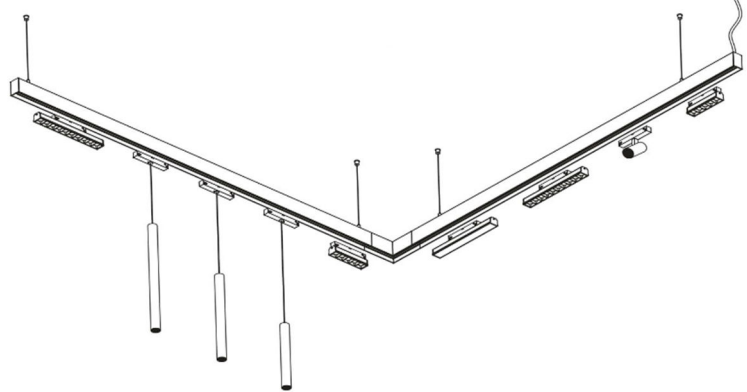

CASE STUDY:

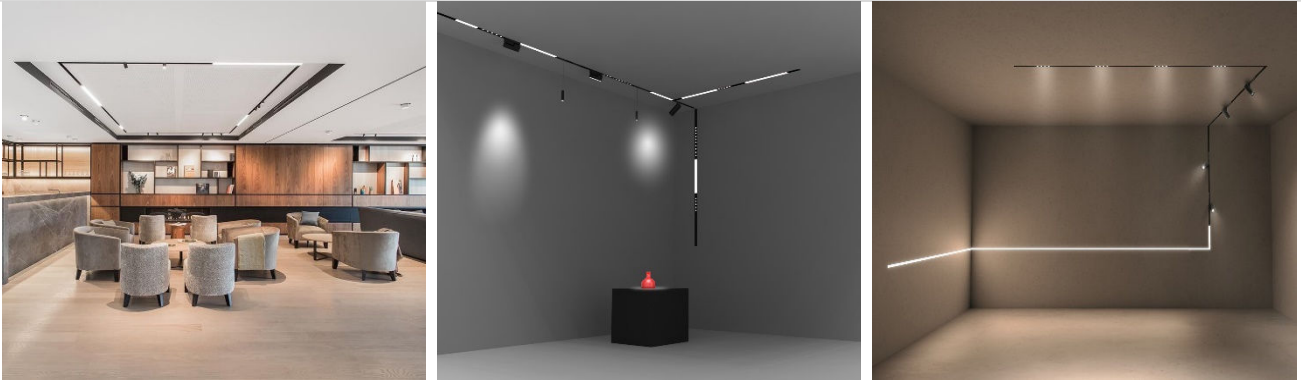

W20 MAGNETIC TRACK: SURFACE MODEL: TM20A-MF20A DIMENSION [UNIT: MM] INSTALLATION SURFACE PENDANT

Installation: Surface Mounted or Pendant
 Housing: Extruded Aluminum Profile
 Conductor: Copper Insulated in PVC
 2 Circuits: Maxi.6A, DC0~60V
 Length: 1-meter, 2-meter, 3-meter

HORIZONTAL "L"	VERTICAL "L"	TRACK CONNECTOR		PENDANT KIT	POWER CONNECTOR		
TM20A-MF20A-LH1	TM20A-MF20A-LV1	HORIZONTAL "T"	HORIZONTAL "X"	TM20A-MF20A-PCW	POWER FEED	INTERFACE	INTERFACE
		TM20A-MF20A-T1	TM20A-MF20A-X1		TM20-PE1	TM20-PS1	TM20-PF1
100x100x22	100x100x59	180x300x22	300x300x22	L2M			





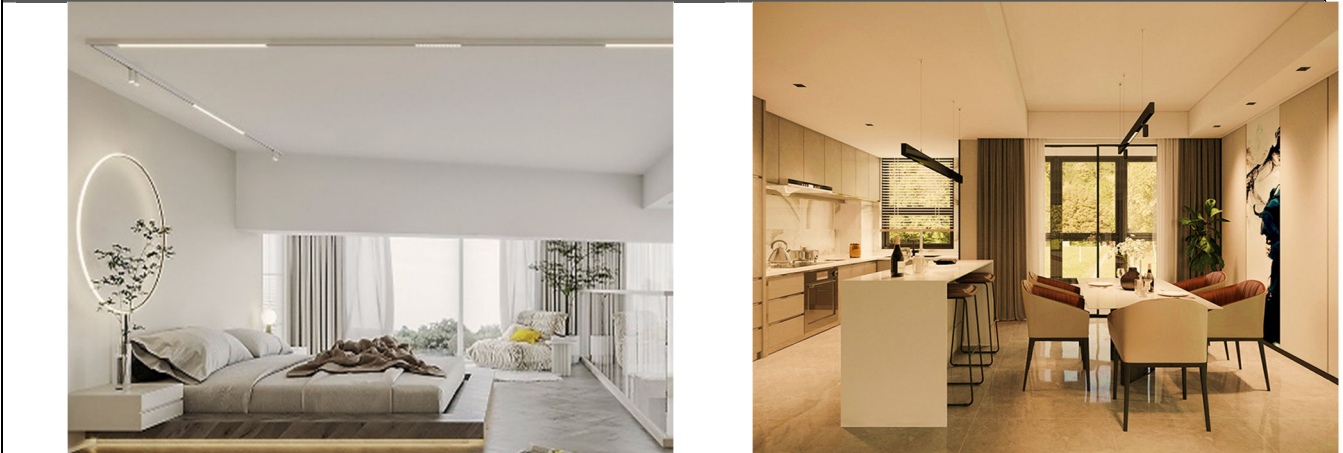



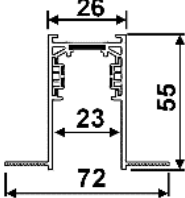
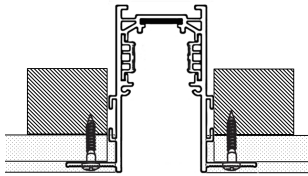

CASE STUDY: SURFACE MOUNTED





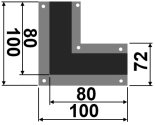
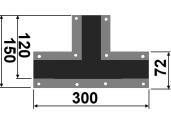
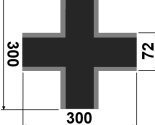

CASE STUDY: PENDANT

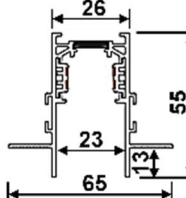
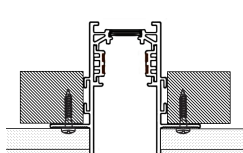
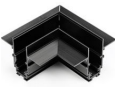

W20 MAGNETIC TRACK: UP&DOWN		MODEL: TM20A-MFB		DIMENSION [UNIT: MM]		INSTALLATION PENDANT	
		<p>INSTALLATION: PENDANT Housing: Extruded Aluminum Profile Conductor: Copper Insulated in PVC 2 Circuits: Maxi.6A, DC0~60V Length: 1-meter, 2-meter, 3-meter</p>					
HORIZONTAL "L" TM20A-MFB-LH1	VERTICAL "L" TM20A-MFB-LV1	TRACK CONNECTOR HORIZONTAL "T" TM20A-MFB-T1	HORIZONTAL "X" TM20A-MFB-X1	PENDANT KIT TM20A-MFB-PCW	POWER FEED TM20-PE1	POWER CONNECTOR INTERFACE TM20-PS1	INTERFACE TM20-PF1
				L2M			
CASE STUDY: PENDANT				CASE STUDY: PENDANT			

W20 MAGNETIC TRACK: RECESSED		MODEL: TM20A-MRT		DIMENSION [UNIT: MM]		INSTALLATION RECESSED	
		<p>INSTALLATION: RECESSED Housing: Extruded Aluminum Profile Conductor: Copper Insulated in PVC 2 Circuits: Maxi.6A, DC0~60V Length: 1-meter, 2-meter, 3-meter</p>		<p>CUTOUT: W30mm</p>			
HORIZONTAL "L" TM20A-MRT-LH1	VERTICAL "L" TM20A-MRT-LV1	TRACK CONNECTOR HORIZONTAL "T" TM20A-MRT-T1	HORIZONTAL "X" TM20A-MRT-X1	POWER FEED TM20-PE1	POWER CONNECTOR INTERFACE TM20-PS1	INTERFACE TM20-PF1	
CASE STUDY:				CASE STUDY:			

W20 MAGNETIC TRACK: TRIMLESS MODEL: TM20A-MRL				DIMENSION [UNIT: MM]	INSTALLATION	
 <p>INSTALLATION: TRIMLESS Housing: Extruded Aluminum Profile Conductor: Copper Insulated in PVC 2 Circuits: Maxi.6A, DCO~60V Length: 1-meter, 2-meter, 3-meter</p>				<p>CUTOUT:30</p> 		
HORIZONTAL "L" TM20A-MRL-LH1	VERTICAL "L" TM20A-MRL-LV1	TRACK CONNECTOR HORIZONTAL "T" TM20A-MRL-T1	HORIZONTAL "X" TM20A-MRL-X1	POWER FEED TM20-PE1	POWER CONNECTOR INTERFACE TM20-PS1	INTERFACE TM20-PF1
						
						
CASE STUDY:				CASE STUDY:		
						

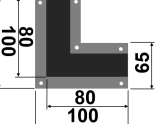
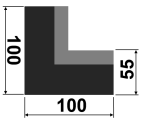
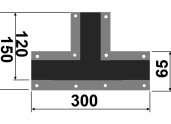
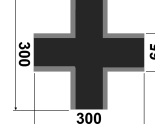
W20 MAGNETIC TRACK: TRIMLESS MODEL: TM20A-MRM				DIMENSION [UNIT: MM]	INSTALLATION	
 <p>INSTALLATION: TRIMLESS Housing: Extruded Aluminum Profile Conductor: Copper Insulated in PVC 2 Circuits: Maxi.6A, DCO~60V Length: 1-meter, 2-meter, 3-meter</p>				<p>CUTOUT:30</p> 		
HORIZONTAL "L" TM20A-MRM-LH1	VERTICAL "L" TM20A-MRM-LV1	TRACK CONNECTOR HORIZONTAL "T" TM20A-MRM-T1	HORIZONTAL "X" TM20A-MRM-X1	POWER FEED TM20-PE1	POWER CONNECTOR INTERFACE TM20-PS1	INTERFACE TM20-PF1
						
						
CASE STUDY:				CASE STUDY:		
