

Specifications

Construction:

- The rugged, one-piece die-cast aluminum housing features a complete heat sink that optimizes heat dissipation through convection cooling management.
- Low profile, 3G vibration rated compact design minimizes wind load requirements.
- Housing is completely sealed against moisture and environmental contaminants.

Optics:

- Available in IES Type II, III, IV, V distributions
- Light engines are available in adjustable color temperature (3000K&4000K&5000K) configurations.
- Scalable Lumen Packages from 6,600 to 61,000 Lumens replaces up to 1000W Metal Halide.
- Optics is precisely designed to shape the distribution, maximizing efficiency and application spacing.
- The optics can conform to dark sky requirement.

Electrical:

- Universal 120-277 VAC or 347-480 VAC input voltage
- 10KA(@120-277V) or 20KA(@347-480V) surge protection
- Standard with 0-10V dimming driver
- Power adjustable: 100%, 80%, 60%, 40%.
- THD: ≤20%
- Power Factor: ≥90%

Controls:

- Optional Occupancy sensor or Microwave sensor.
- Optional Bluetooth sensor or Bluetooth controller.
- Optional NEMA 3-pin photocell or 7-pin photocell.

Ambient Temperature:

- Ambient operating temperature -40°C to 45°C (-40°F to 113°F).
- The ambient temperature of 400W is: -40°C to 40°C.

Installation:

- Suitable for mounting heights ranging from 26-50' in area lighting applications
- Round pole, Square pole, slipfitter, wall mount and yoke are available.
- The design can be operated by one person to install the whole lamp

Lifespan:

- Estimated 100,000-hour LED lifespan based on IES LM-80 results and TM-21 calculations

Finish:

- It's available in black or optional dark bronze, silvery gray or white.



Medium Size: 100W/140W/180W



Large Size: 250W/300W/400W



Certifications:

- UL wet location listed
- DesignLights Consortium™ Qualified.
 Note: DesignLights Consortium™ Qualified and classified for DLC Premium, refer to www.designlights.org for details.

Note:

Actual performance may differ as a result of end-user environment and application. All values are design or typical values, measured under laboratory conditions at 25°C (±5°C) specifications subject to change without notice.

Structural Design

Housing
 The one-piece die-cast housing with corrosion-resistant coating protection and the modular design extend the life of the luminaire while making it easy to maintain.

Photometry
 Optional Type II, Type III, Type IV and Type V Photometry as per applications.

Photocell
 Dusk to dawn controls can be utilized via optional NEMA twist-lock photocell.

CCT & POWER Adjustable
 Offer four selectable lumen output (40%/60%/80%/100%), and three selectable CCTs (30K/40K/50K)

POWER	CCT
LV1	5KK
LV2	4KK
LV3	3KK
LV4	

Mounting
 Optional for square, round pole mount, Slipfitter, wall mount, yoke mount. All mounting brackets are simple to operate, which can realize single operation and reduce labor costs.

Occupancy Sensor
 Optional occupancy sensor allows for security and energy saving.

PERFORMANCE DATA

ARI 8 100W									
SETTING	SYSTEM WATTS	DIST.TYPE	CRI	3000K		4000K		5000K	
				LUMENS	LPW	LUMENS	LPW	LUMENS	LPW
100%	100W	2	70	14500lm	145 lm/W	15800lm	158 lm/W	15000lm	150 lm/W
		3	70	14500lm	145 lm/W	15800lm	158 lm/W	15000lm	150 lm/W
		4	70	14500lm	145 lm/W	15800lm	158 lm/W	15000lm	150 lm/W
		5	70	15100lm	151 lm/W	16000lm	160 lm/W	15600lm	156 lm/W
80%	80W	2	70	12000lm	150 lm/W	13000lm	163 lm/W	12500lm	156 lm/W
		3	70	12000lm	150 lm/W	13000lm	163 lm/W	12500lm	156 lm/W
		4	70	12000lm	150 lm/W	13000lm	163 lm/W	12500lm	156 lm/W
		5	70	12500lm	156 lm/W	13300lm	166 lm/W	12800lm	160 lm/W
60%	60W	2	70	9300lm	155 lm/W	10000lm	167 lm/W	9600lm	160 lm/W
		3	70	9300lm	155 lm/W	10000lm	167 lm/W	9600lm	160 lm/W
		4	70	9300lm	155 lm/W	10000lm	167 lm/W	9600lm	160 lm/W
		5	70	9600lm	160 lm/W	10200lm	170 lm/W	9850lm	164 lm/W
40%	40W	2	70	6400lm	160 lm/W	6800lm	170 lm/W	6560lm	164 lm/W
		3	70	6400lm	160 lm/W	6800lm	170 lm/W	6560lm	164 lm/W
		4	70	6400lm	160 lm/W	6800lm	170 lm/W	6560lm	164 lm/W
		5	70	6560lm	164 lm/W	7000lm	175 lm/W	6700lm	168 lm/W

ARI 8 140W									
SETTING	SYSTEM WATTS	DIST.TYPE	CRI	3000K		4000K		5000K	
				LUMENS	LPW	LUMENS	LPW	LUMENS	LPW
100%	140W	2	70	20000lm	147 lm/W	23000lm	164 lm/W	21000lm	150 lm/W
		3	70	20000lm	147 lm/W	23000lm	164 lm/W	21000lm	150 lm/W
		4	70	20000lm	147 lm/W	23000lm	164 lm/W	21000lm	150 lm/W
		5	70	21000lm	150 lm/W	23500lm	168 lm/W	21500lm	154 lm/W
80%	120W	2	70	18000lm	150 lm/W	20000lm	167 lm/W	18500lm	154 lm/W
		3	70	18000lm	150 lm/W	20000lm	167 lm/W	18500lm	154 lm/W
		4	70	18000lm	150 lm/W	20000lm	167 lm/W	18500lm	154 lm/W
		5	70	18500lm	154 lm/W	20500lm	171 lm/W	19000lm	158 lm/W
60%	90W	2	70	13800lm	153 lm/W	15200lm	169 lm/W	14200lm	158 lm/W
		3	70	13800lm	153 lm/W	15200lm	169 lm/W	14200lm	158 lm/W
		4	70	13800lm	153 lm/W	15200lm	169 lm/W	14200lm	158 lm/W
		5	70	14000lm	156 lm/W	15600lm	172 lm/W	14500lm	161 lm/W
40%	60W	2	70	9400lm	157 lm/W	10300lm	172 lm/W	9700lm	162 lm/W
		3	70	9400lm	157 lm/W	10300lm	172 lm/W	9700lm	162 lm/W
		4	70	9400lm	157 lm/W	10300lm	172 lm/W	9700lm	162 lm/W
		5	70	9600lm	160 lm/W	10500lm	175 lm/W	10000lm	167 lm/W

ARI 8 180W									
SETTING	SYSTEM WATTS	DIST.TYPE	CRI	3000K		4000K		5000K	
				LUMENS	LPW	LUMENS	LPW	LUMENS	LPW
100%	180W	2	70	24800lm	138 lm/W	27000lm	150 lm/W	25200lm	140 lm/W
		3	70	24800lm	138 lm/W	27000lm	150 lm/W	25200lm	140 lm/W
		4	70	24800lm	138 lm/W	27000lm	150 lm/W	25200lm	140 lm/W
		5	70	25500lm	142 lm/W	28000lm	156 lm/W	26000lm	144 lm/W
80%	144W	2	70	20200lm	140 lm/W	22000lm	153 lm/W	20600lm	143 lm/W
		3	70	20200lm	140 lm/W	22000lm	153 lm/W	20600lm	143 lm/W
		4	70	20200lm	140 lm/W	22000lm	153 lm/W	20600lm	143 lm/W
		5	70	20800lm	144 lm/W	22800lm	158 lm/W	21000lm	146 lm/W
60%	108W	2	70	15300lm	142 lm/W	16800lm	156 lm/W	15700lm	145 lm/W
		3	70	15300lm	142 lm/W	16800lm	156 lm/W	15700lm	145 lm/W
		4	70	15300lm	142 lm/W	16800lm	156 lm/W	15700lm	145 lm/W
		5	70	15800lm	146 lm/W	17300lm	160 lm/W	16200lm	150 lm/W
40%	72W	2	70	10500lm	146 lm/W	11500lm	160 lm/W	10800lm	150 lm/W
		3	70	10500lm	146 lm/W	11500lm	160 lm/W	10800lm	150 lm/W
		4	70	10500lm	146 lm/W	11500lm	160 lm/W	10800lm	150 lm/W
		5	70	10800lm	150 lm/W	11800lm	164 lm/W	11000lm	153 lm/W

ARI 8 250W									
SETTING	SYSTEM WATTS	DIST.TYPE	CRI	3000K		4000K		5000K	
				LUMENS	LPW	LUMENS	LPW	LUMENS	LPW
100%	250W	2	70	33500lm	134 lm/W	37000lm	148 lm/W	34500lm	138 lm/W
		3	70	33500lm	134 lm/W	37000lm	148 lm/W	34500lm	138 lm/W
		4	70	33500lm	134 lm/W	37000lm	148 lm/W	34500lm	138 lm/W
		5	70	34500lm	138 lm/W	38000lm	152 lm/W	35500lm	142 lm/W
80%	200W	2	70	27500lm	138 lm/W	30400lm	152 lm/W	28400lm	142 lm/W
		3	70	27500lm	138 lm/W	30400lm	152 lm/W	28400lm	142 lm/W
		4	70	27500lm	138 lm/W	30400lm	152 lm/W	28400lm	142 lm/W
		5	70	28000lm	140 lm/W	31000lm	155 lm/W	28800lm	144 lm/W
60%	150W	2	70	21300lm	142 lm/W	23200lm	155 lm/W	21800lm	145 lm/W
		3	70	21300lm	142 lm/W	23200lm	155 lm/W	21800lm	145 lm/W
		4	70	21300lm	142 lm/W	23200lm	155 lm/W	21800lm	145 lm/W
		5	70	21800lm	145 lm/W	23800lm	159 lm/W	22500lm	150 lm/W
40%	100W	2	70	14500lm	145 lm/W	16000lm	160 lm/W	14800lm	148 lm/W
		3	70	14500lm	145 lm/W	16000lm	160 lm/W	14800lm	148 lm/W
		4	70	14500lm	145 lm/W	16000lm	160 lm/W	14800lm	148 lm/W
		5	70	15000lm	150 lm/W	16500lm	165 lm/W	15500lm	155 lm/W

ARI 8 300W									
SETTING	SYSTEM WATTS	DIST.TYPE	CRI	3000K		4000K		5000K	
				LUMENS	LPW	LUMENS	LPW	LUMENS	LPW
100%	300W	2	70	41000lm	137 lm/W	45000lm	150 lm/W	42000lm	140 lm/W
		3	70	41000lm	137 lm/W	45000lm	150 lm/W	42000lm	140 lm/W
		4	70	41000lm	137 lm/W	45000lm	150 lm/W	42000lm	140 lm/W
		5	70	42500lm	142 lm/W	46000lm	153 lm/W	43500lm	145 lm/W
80%	240W	2	70	33600lm	140 lm/W	37000lm	154 lm/W	34500lm	144 lm/W
		3	70	33600lm	140 lm/W	37000lm	154 lm/W	34500lm	144 lm/W
		4	70	33600lm	140 lm/W	37000lm	154 lm/W	34500lm	144 lm/W
		5	70	34500lm	144 lm/W	38000lm	158 lm/W	35500lm	148 lm/W
60%	180W	2	70	26000lm	144 lm/W	28600lm	159 lm/W	26600lm	148 lm/W
		3	70	26000lm	144 lm/W	28600lm	159 lm/W	26600lm	148 lm/W
		4	70	26000lm	144 lm/W	28600lm	159 lm/W	26600lm	148 lm/W
		5	70	26600lm	148 lm/W	29700lm	165 lm/W	27500lm	153 lm/W
40%	120W	2	70	18000lm	150 lm/W	20000lm	167 lm/W	18500lm	154 lm/W
		3	70	18000lm	150 lm/W	20000lm	167 lm/W	18500lm	154 lm/W
		4	70	18000lm	150 lm/W	20000lm	167 lm/W	18500lm	154 lm/W
		5	70	18500lm	154 lm/W	20800lm	173 lm/W	19000lm	158 lm/W

ARI 8 400W							
SETTING	SYSTEM WATTS	DIST.TYPE	CRI	4000K		5000K	
				LUMENS	LPW	LUMENS	LPW
LV1	400W	2	70	60500lm	151 lm/W	60000lm	150 lm/W
		3	70	60500lm	151 lm/W	60000lm	150 lm/W
		4	70	60500lm	151 lm/W	60000lm	150 lm/W
		5	70	61000lm	153 lm/W	60800lm	152 lm/W
LV2	360W	2	70	56000lm	156 lm/W	55000lm	153 lm/W
		3	70	56000lm	156 lm/W	55000lm	153 lm/W
		4	70	56000lm	156 lm/W	55000lm	153 lm/W
		5	70	56500lm	157 lm/W	55500lm	154 lm/W
LV3	320W	2	70	51000lm	159 lm/W	50000lm	156 lm/W
		3	70	51000lm	159 lm/W	50000lm	156 lm/W
		4	70	51000lm	159 lm/W	50000lm	156 lm/W
		5	70	51500lm	161 lm/W	50500lm	159 lm/W
LV4	300W	2	70	47000lm	162 lm/W	46000lm	159 lm/W
		3	70	47000lm	162 lm/W	46000lm	159 lm/W
		4	70	47000lm	162 lm/W	46000lm	159 lm/W
		5	70	47500lm	164 lm/W	46500lm	160 lm/W

BUG @5000K

SYSTEM WATTS	VOLTAGE	DIST. TYPE	B	U	G
100W	120-277V/347-480V	2	3	0	3
		3	3	0	3
		4	3	0	2
		5	4	0	2
140W	120-277V/347-480V	2	3	0	3
		3	3	0	3
		4	3	0	3
		5	4	0	2
180W	120-277V/347-480V	2	4	0	3
		3	3	0	3
		4	3	0	3
		5	4	0	2
250W	120-277V/347-480V	2	4	0	4
		3	4	0	4
		4	4	0	3
		5	5	0	3
300W	120-277V/347-480V	2	5	0	4
		3	4	0	4
		4	4	0	4
		5	5	0	4
400W	120-277V/347-480V	2	5	0	4
		3	5	0	5
		4	5	0	5
		5	5	0	4

ELECTRICAL DATA

Number Of Drivers	Driver Current (mA)	Nominal Power (W)	INPUT VOLTAGE (V)	CURRENT (Amps)
1	850	100	120	0.83
		100	208	0.48
		100	240	0.42
		100	277	0.36
	2520	100	347	0.29
		100	480	0.21
1	1200	140	120	1.17
		140	208	0.67
		140	240	0.58
		140	277	0.51
		140	347	0.40
		140	480	0.29
1	960	180	120	1.50
		180	208	0.87
		180	240	0.75
		180	277	0.65
		180	347	0.52
		180	480	0.38
1	1200	250	120	2.08
		250	208	1.20
		250	240	1.04
		250	277	0.90
		250	347	0.72
		250	480	0.52
1	1500	300	120	2.50
		300	208	1.44
		300	240	1.25
		300	277	1.08
		300	347	0.86
		300	480	0.63
1	1460	400	120	3.33
		400	208	1.92
		400	240	1.67
		400	277	1.44
		400	347	1.15
		400	480	0.83

MOUNTING

- Standard versatile mounting arm accommodates multiple drilling patterns as well as square and round poles
- Optional for cast aluminum slipfitter mounting adapter (Compatible with mounting adaptors such as Tenon, suits for various application)

Mounting Options



Arm Mount
(4" and 5" Square and Round poles)
Standard versatile mounting arm is simple to install and can be used with existing poles for retrofit installations.



Slipfitter Mount
An optional cast aluminum mast arm adapter secures fixture head to nominal 2-3/8" O.D. horizontal steel tenon arm.



Wall Mount
Wall Mount is easy to install for direct wall mounting with 1/2" conduit wiring or standard J-box mounting



Yoke Mount
Die-cast aluminum trunnion is easily adapted to many surfaces and allows easy fixture aiming angles.



Adjustable Arm Mount
Standard versatile mounting arm is simple to install and can be used with existing poles for retrofit installations.

Mounting Dimensions

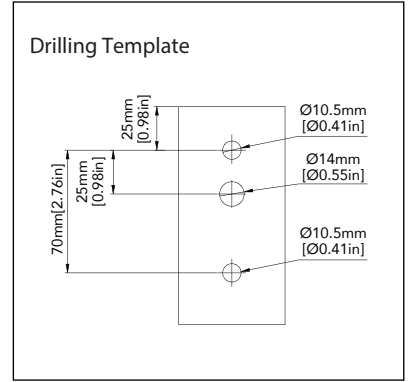
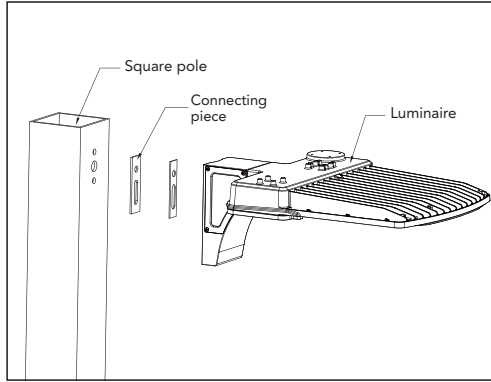
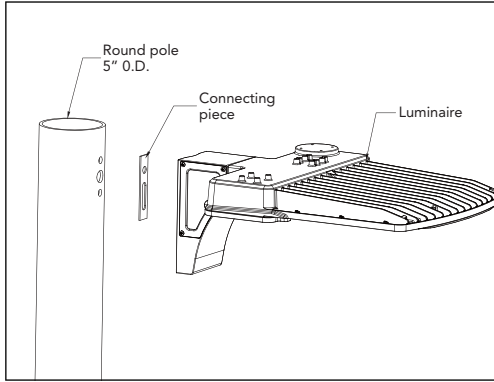

DIMENSION

unit: inch/mm

100W/140W/180W (Adjustable Square Mount)

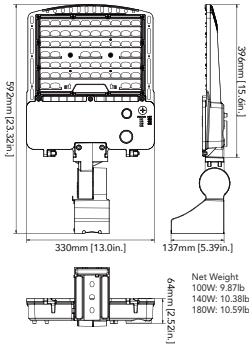

100W/140W/180W (Slipfitter Mount)

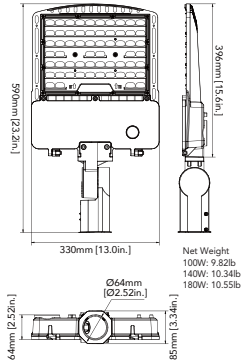

100W/140W/180W (Wall Mount)

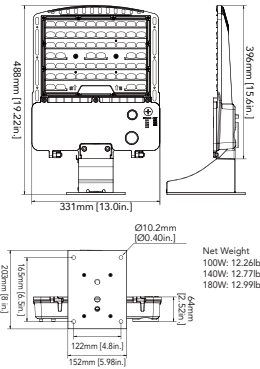

100W/140W/180W (Pole Mount)

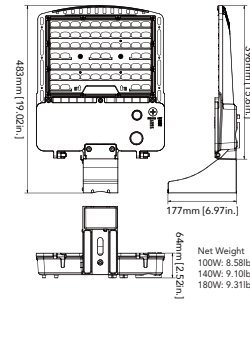

100W/140W/180W (Yoke Mount)

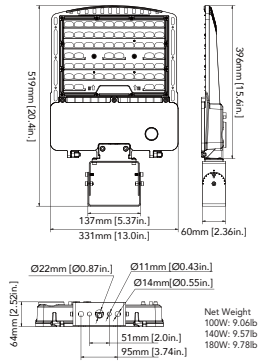

250W/300W/400W (Adjustable Square Mount)

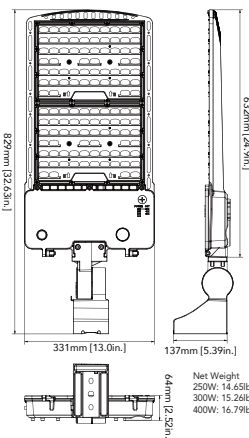

250W/300W/400W (Slipfitter Mount)

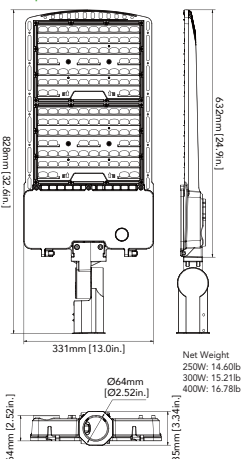

250W/300W/400W (Wall Mount)

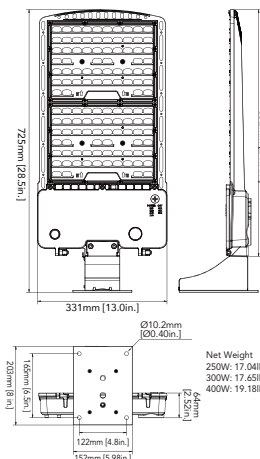



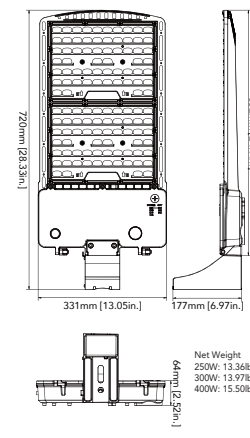

250W/300W/400W (Pole Mount)

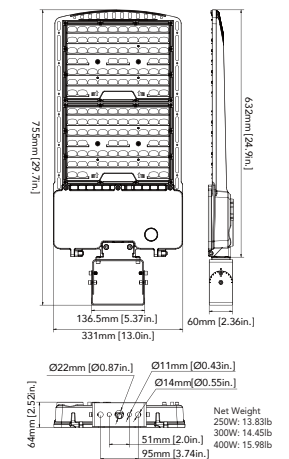

250W/300W/400W (Yoke Mount)

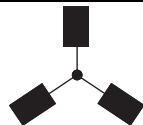
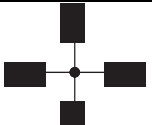

EPA OF AREA LIGHT

Item							
	1	2 @90°	2 @120°	2@180°	3 @90°	3 @120°	4 @90°
100W/140W/180W	0.3632	0.6849	0.8861	0.7264	1.0481	1.2078	1.0481
250W/300W/400W	0.4758	0.8091	1.059	0.9516	1.2849	1.3923	1.2849

PHOTOMETRICS

ARI 8 offers a complete set of optical systems to meet every site lighting requirement. These systems provide remarkable flexibility in precisely matching light distribution patterns to specific site requirements.

Type 2 optics are ideal for applications where there is a need to space the luminaires farther apart along a road or pathway. The light distribution pattern is optimized for elongated areas, allowing for greater pole spacing without sacrificing lighting quality.

Type 3 optics produce an asymmetrical pattern that directs the majority of the light forward and equally on both sides of the luminaire. In a back-to-back configuration, it creates a rectangular pattern which can extend pole spacings.

Type 4 is suitable for applications where light is primarily required forward with minimal backlight. Typical installations include perimeter poles.

Type 5 optics produce a symmetrical square distribution pattern that distributes light equally on all sides of the luminaire. Type 5 luminaires is universal for most area lighting applications

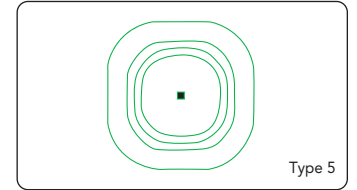
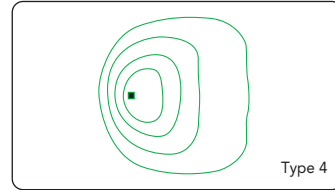
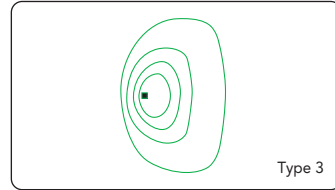
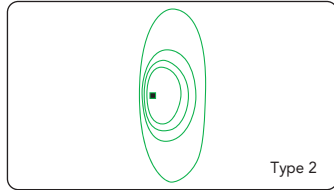

ORDERING GUIDE Example: ARI 8 140W 27V XXK Y Y Y Y Y

Fixture Type	Wattage	Voltage	CCT	Finish	Photocell (Option)	Sensor (Option)	Mounting	Photometry	CCT and Power Adjustable	Internal Code
<input type="checkbox"/>	<input type="checkbox"/>	<input type="checkbox"/>	<input type="checkbox"/>	<input type="checkbox"/>	<input type="checkbox"/>	<input type="checkbox"/>	<input type="checkbox"/>	<input type="checkbox"/>	<input type="checkbox"/>	<input type="checkbox"/>
ARI 8	100 100W	27V 120-277V	DDK¹	D Dark Bronze	P0 120-277V Photocell	M With Sensor	SQ Square Pole Mount	T2 TYPE II	AD¹	Blank
Area Light Series	140 140W	48V 347-480V	Adjustable color temperature	B Black	P3 347V Photocell	Blank Without Sensor	SP Slipfitter Mount	T3 TYPE III	With adjustment dia	Alphanumeric
	180 180W			W White	P4 480V Photocell		WM Wall Mount	T4 TYPE IV	Blank	
	250 250W			SG Silver Gray	Blank Without Photocell		YK Yoke Mount	T5 TYPE V	Without adjustment dia	
	300 300W						SQA Adjustable Square Mount			
	400 400W									

Note: Only 400W suit for 4000K, 5000K adjustable and other wattage suit for 3000K, 4000K and 5000K adjustable.

We do try to keep the highlighted in US stock. Please email to check for US Stock

ACCESSORIES(Optional)

ARI 8 series features a backlight control which provides reduced pixilation and increased visual comfort without compromising performance. External Glare Shield: sold separately or as an accessory.

			
External Glare Shield		External Glare Full Visor	
			
Plug-and-Play PIR Sensor PIR sensor: ANT-6-4T Bluetooth PIR sensor: ANT-6-4T-BLE-SR	Plug-and-Play Microwave Sensor Microwave sensor: ANT-5-4T Bluetooth microwave sensor: ANT-5-4T-BLE-SR	120-277V PIR Sensor PIR sensor: BRI823-B-D Bluetooth PIR sensor: BRI823-B-D-BLE-SR	NEMA Photocell 3 pin NEMA Type: MS-PSUNVB1 3 pin NEMA Type(480V): JL-207F 7 pin NEMA Type: JL-241C
			
Back Light Control Shield			

ADDITIONAL MOUNTING ACCESSORIES

POLE BRACKET • For mounting one fixture on an existing pole			
	<p>4\" Square Pole Mount with 2-3/8\" O.D. Tenon No. 4SQ-SP-D Finish: Dark Bronze USE: For use with square, non-tapered steel and aluminum poles. Furnished with four 5/16\" hex head stainless-steel bolts. Vertical tenon measures 2-3/8\" O.D., and is made of steel tubing. Fixtures mounted to this bracket can be adjusted both vertically and horizontally.</p>		<p>4\" Round Pole Mount with 2-3/8\" O.D. Tenon NO. 4SR-SP-D Finish: Dark Bronze USE: For use with Round, non-tapered steel and aluminum poles. Furnished with three 3/8\" hex head stainless-steel bolts. Vertical tenon measures 2-3/8\" O.D., and is made of steel tubing. Fixtures mounted to this bracket can be adjusted both vertically and horizontally.</p>
	<p>5\" Square Pole Mount with 2-3/8\" O.D. Tenon No. 5SQ-SP-D Finish: Dark Bronze USE: For use with square, non-tapered steel and aluminum poles. Furnished with four 5/16\" hex head stainless-steel bolts. Vertical tenon measures 2-3/8\" O.D., and is made of steel tubing. Fixtures mounted to this bracket can be adjusted both vertically and horizontally.</p>		<p>5\" Round Pole Mount with 2-3/8\" O.D. Tenon NO. 5SR-SP-D Finish: Dark Bronze USE: For use with Round, non-tapered steel and aluminum poles. Furnished with three 3/8\" hex head stainless-steel bolts. Vertical tenon measures 2-3/8\" O.D., and is made of steel tubing. Fixtures mounted to this bracket can be adjusted both vertically and horizontally.</p>
	<p>Pole Bracket Accessories - Angle-Adjustment Adapter NO. SQA-ALDA Finish: Dark Bronze USE: Durable brackets are engineered to provide versatile mounting options. These arms are made from rugged die-cast aluminum. They allow optimal positioning of the light fixture to maximize the lighting effectiveness vertically and horizontally.</p>		<p>Pole Bracket accessories - Tenon & Yoke Adaptor NO. SP-TR-D Finish: Dark Bronze USE: The 2-3/8\" OD Tenon Mount Adaptor for Yoke Fixtures is designed to mount light fixtures that are equipped with a yoke mount onto a 2-3/8\" OD tenon. It may be utilized with the Flood Light Series of light fixtures.</p>
	<p>Horizontal Wall or Square or Round pole mount with 2-3/8\" Tenon Bracket NO. SQ/R-SP-D Finish: Dark Bronze USE: This tenon bracket can be installed onto a wall, square pole, round pole. Provides wiring access and abut-in 2-3/8\" O.D. tenon to mount a fixture with our adjustable slipfitter. Suggested 3/8\" diameter bolts for mounting.</p>		
WALL BRACKET • Attaches to any flat surface • Provides wiring access		Mid-Pole tenon Bracket	
	<p>90\" Wall Mount Bracket with 2-3/8\" O.D. Tenon NO. WM-SP-D Finish: Dark Bronze USE: The 90\" wall mount bracket with 2-3/8\" tenon attaches an floodlight to almost any surface: wall, roof, or wood pole. Provides wiring access and abut-in 2-3/8\" O.D. tenon to mount a fixture with our adjustable slipfitter. Suggested 3/8\" diameter bolts for mounting. Mounting holes are spaced 3-1/4\" apart.</p>		<p>2-3/8\" OD Horizontal Tenon Mid-Pole Bracket NO. SQ-SP-D Finish: Dark Bronze USE: 2-3/8\" OD Horizontal Tenon Mid-Pole Bracket is designed to mount light fixture that is equipped with an adjustable slipfitter onto a 2-3/8\" OD horizontal tenon</p>
Round External Mount Horizontal Tenon • To mount 2/3/4 fixtures on a existing pole			
	<p>Double 90\" Horizontal Tenon Adaptor NO. R60-SP2-90-D Finish: Dark Bronze USE: The Bracket is designed to mount over 2-3/8\" (60mm) O.D. vertical tenon. Two fixtures can be mounted to the Round External Mount Horizontal Tenon and adjusted horizontally</p>		<p>Triple 120\" Horizontal Tenon Adaptor NO. R60-SP3-120-D Finish: Dark Bronze USE: The Bracket is designed to mount over 2-3/8\" (60mm) O.D. vertical tenon. Three fixtures can be mounted to the Round External Mount Horizontal Tenon and adjusted horizontally</p>
	<p>Double 180\" Horizontal Tenon Adaptor NO. R60-SP2-180-D Finish: Dark Bronze USE: The Bracket is designed to mount over 2-3/8\" (60mm) O.D. vertical tenon. Two fixtures can be mounted to the Round External Mount Horizontal Tenon and adjusted horizontally</p>		<p>Quad 90\" Horizontal Tenon Adaptor NO. R60-SP4-90-D Finish: Dark Bronze USE: The Bracket is designed to mount over 2-3/8\" (60mm) O.D. vertical tenon. Four fixtures can be mounted to the Round External Mount Horizontal Tenon and adjusted horizontally</p>
	<p>Triple 90\" Horizontal Tenon Adaptor NO. R60-SP3-90-D Finish: Dark Bronze USE: The Bracket is designed to mount over 2-3/8\" (60mm) O.D. vertical tenon. Three fixtures can be mounted to the Round External Mount Horizontal Tenon and adjusted horizontally</p>		