

## INTRODUCTION

### FEATURE

- Unique Modular Waterproof Design
- Multiple Accessories for Optimized Garden Lighting
- Long Lifespan Design >50,000hours
- Working Temperature: -30°C~50°C

### MAIN MATERIAL

- LED Brand: GUBO
- Driver Brand: GUBO
- Housing: Die-casted Aluminum
- [5R] Optics: High Efficiency PC Reflector
- Diffuser: Clear Tempered Glass

### INSTALLATION

- Suitable for Interior & Exterior Lighting
- [FWA]: Wall Surface Mounted
- [FSC]: Slip Fitter Mounted
- [PSA]: Aluminum Straight Bollard
- NOTES: Custom Installation and Accessories Referred to Another Catalogue of Fixing Kits.**

### STANDARD

- Designed and Manufactured to Comply with CE/RoHS/CB/cETL/SAA/SASO Standard
- IP65 Protection, Class III Electric

### OPTIONS

- LED CCT: 1,600K~10,000K/R/G/B/Y
- [CRI]: [E] RA80, [G] RA90, [H] RA97(RG0)
- F1: Custom Housing Finish Colors by RAL Code
- [BGB]: Custom Baffle Finish Colors by RAL Code

WHITE	BLACK	GREY	DARK GREY	BRASS
RAL9010P	RAL9005P	RAL7042P	RAL7016P	RAL1024P

## GTG2201B: ROUND LED GAREN SPOTLIGHT



(MCA95A) [FSC25D]	(MCA140A) [FSC25D]	(MCA225A) [FSC42D]	(MCA280A) [FSC42D]
----------------------	-----------------------	-----------------------	-----------------------



### OPTIONAL ACCESSOIRES [FACTORY SET]

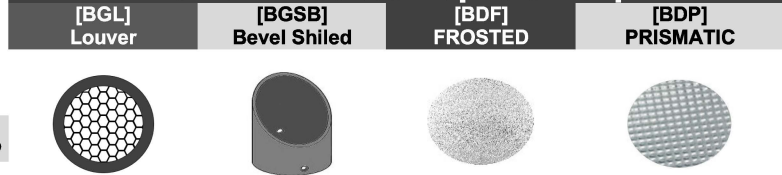

MODEL	POWER [W]	LED TYPE	CCT [K]	CRI	FLUX [LM]	POWER FACTOR	BEAM ANGLE	REMOTE CONTROL	INPUT [V]
GTG2201B-MCA65A5R	7W	CXM-6 COB	G2700K	RA90	460	>0.9			
			G3000K	RA90	480				
			G3500K	RA90	480				
			G4000K	RA90	520				
			G5000K	RA90	520				
			G6500K	RA90	500				
	2C@7W	TWG	G2700K	G6500K	RA90	380	>0.7		
3C@7W	RGB	620nm	520nm	460nm	\	380	>0.6		
4C@7W	RGBW	620nm	520nm	460nm	2700K	\	380	>0.5	
4C@7W	RGBA	620nm	520nm	460nm	590nm	\	380	>0.5	
GTG2201B-MCA95A5R	15W [10W]	CXM-6 COB	G2700K	RA90	1060	>0.9			
			G3000K	RA90	1120				
			G3500K	RA90	1120				
			G4000K	RA90	1160				
			G5000K	RA90	1160				
			G6500K	RA90	1130				
	2C@15W	TWG	G2700K	G6500K	RA90	830	>0.8		
3C@15W	RGB	620nm	520nm	460nm	\	830	>0.8		
4C@15W	RGBW	620nm	520nm	460nm	2700K	\	830	>0.7	
4C@15W	RGBA	620nm	520nm	460nm	590nm	\	830	>0.7	
GTG2201B-MCA140A5R	40W [20W] [30W]	CXM-9 COB	G2700K	RA90	2940	>0.9			
			G3000K	RA90	3060				
			G3500K	RA90	3060				
			G4000K	RA90	3190				
			G5000K	RA90	3190				
			G6500K	RA90	3110				
	2C@40W	TWG	G2700K	G6500K	RA90	2130	>0.8		
3C@40W	RGB	620nm	520nm	460nm	\	2130	>0.8		
4C@40W	RGBW	620nm	520nm	460nm	2700K	\	2130	>0.7	
4C@40W	RGBA	620nm	520nm	460nm	590nm	\	2130	>0.7	
GTG2201B-MCA225A5R	60W [40W] [50W] [80W]	CXM-11 COB	G2700K	RA90	4400	>0.9			
			G3000K	RA90	4590				
			G3500K	RA90	4590				
			G4000K	RA90	4790				
			G5000K	RA90	4790				
			G6500K	RA90	4670				
	2C@60W	TWG	G2700K	G6500K	RA90	3190	>0.8		
3C@60W	RGB	620nm	520nm	460nm	\	3190	>0.8		
4C@60W	RGBW	620nm	520nm	460nm	2700K	\	3190	>0.7	
4C@60W	RGBA	620nm	520nm	460nm	590nm	\	3190	>0.7	
GTG2201B-MCA280A5R	100W [60W] [80W] [120W]	CXM-14 COB	G2700K	RA90	7340	>0.9			
			G3000K	RA90	7660				
			G3500K	RA90	7660				
			G4000K	RA90	7980				
			G5000K	RA90	7980				
			G6500K	RA90	7780				
	2C@100W	TWG	G2700K	G6500K	RA90	5320	>0.8		
3C@100W	RGB	620nm	520nm	460nm	\	5320	>0.8		
4C@100W	RGBW	620nm	520nm	460nm	2700K	\	5320	>0.7	
4C@100W	RGBA	620nm	520nm	460nm	590nm	\	5320	>0.7	

NOTE:

All parameters are measured at 25°C ambient temperature, 35% humidity experimental environment. Tolerances of power and luminous flux are ±10%, tolerance of color rendering index is ±5.

[FSC] Circular Slipfitter Spigot

DIMENSION: [UNIT: MM]

NOTES: Custom "FSC" Installation and Accessories Referred to Another Catalogue of Fixing Kits.

MODEL: MCA65A-[FSC25D]

MCA65A-[BGSB]-[FSC25D]

MCA65A-[BGSC]-[FSC25D]

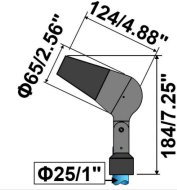
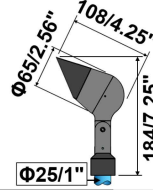
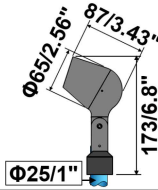

MODEL: MCA95A-[FSC25D]

CASE STUDY: [FHR-C400] Tree Fixing Ring Hoop

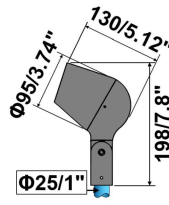

MODEL: MCA140A-[FSC25D]

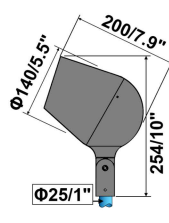

MODEL: MCA225A-[FSC42D]

CASE STUDY: [ACP60] Coupler

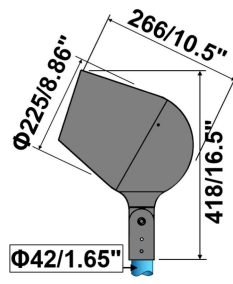

MODEL: MCA280A-[FSC42D]

CASE STUDY: [ACA45D-M2A180D] Curved Arm

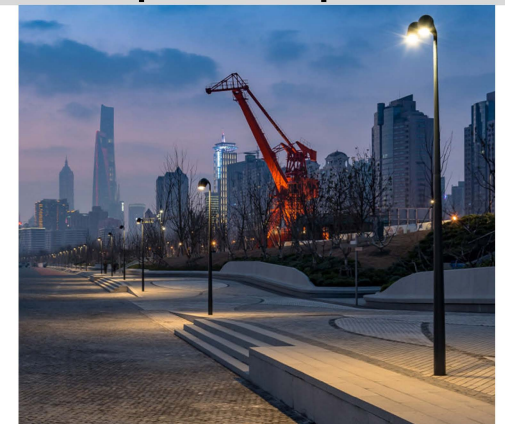
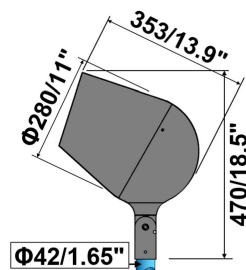

**GTG2201B: ROUND LED GAREN SPOTLIGHT**

**SPECIFICATION**

**MCA140A-[PTA161] Bollard Light by Aluminum Tapered Pole**

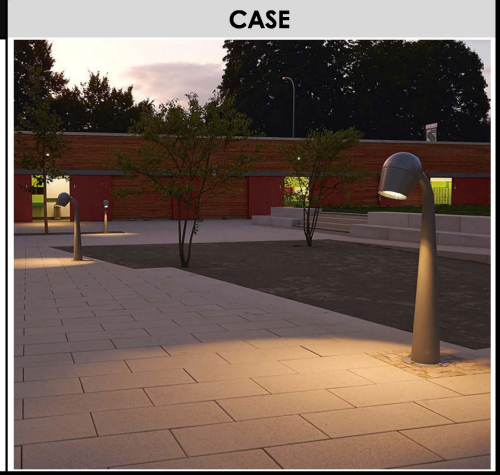
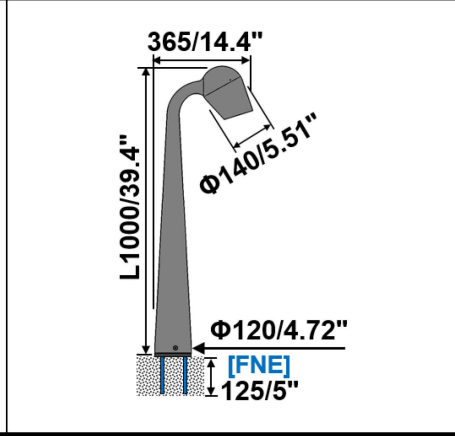
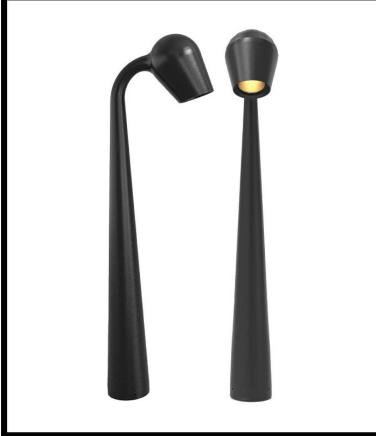

**MCA225A-[PTA161] Bollard Light by Aluminum Tapered Pole**

