

H1 Track System

Single Circuit
120V

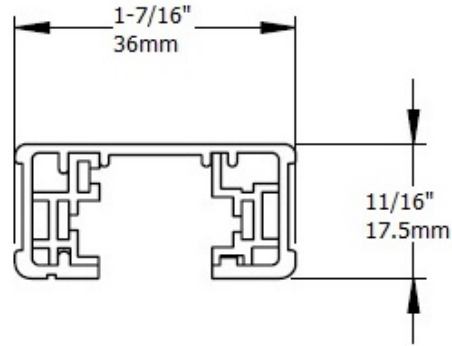
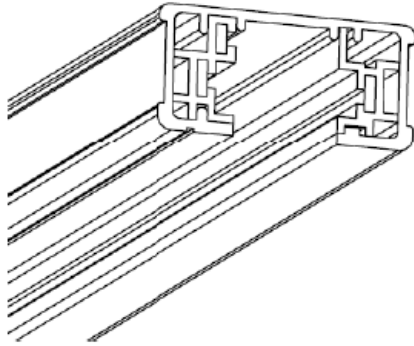

DESCRIPTION

Track / Power Distribution System suitable for retail, commercial and residential use. Compatible with H and H 2 track lighting fixtures. Ships with one **H1EC** (end cap) installed.

CONSTRUCTION

Extruded aluminum housing.
Solid copper bus bars equivalent to #12 AWG wire.
Independent ground conductor.

MOUNTING

Surface mount to finished ceiling. Toggle bolts included.
Suspend from finished ceiling using **HSK100** and appropriate stem.
Add **SK101** adaptor for sloped ceiling.
T-Bar ceiling mount using **TBC**.

ELECTRICAL

120V 50/60 Hz 20A max

LABELS



ORDERING INFORMATION

TRACK SYSTEM	LENGTH	FINISH
H1TR = JESCO H1 Track	2 = 2'	-BK - Black
	4 = 4'	-WT - White
	6 = 6'	
	8 = 8'	

H1TR		-
------	--	---

T-Bar Ceiling

H1TBH	T-Bar outlet box housing
TBC	T-Bar attachment clip

Fixture Extensions

H2HVFE12	12" line voltage fixture extension
H2HVFE18	18" line voltage fixture extension
H2HVFE24	24" line voltage fixture extension
H2HVFE36	36" line voltage fixture extension
H2HVFE48	48" line voltage fixture extension
LVFE06	6" low voltage fixture extension
LVFE12	12" low voltage fixture extension
LVFE18	18" low voltage fixture extension
LVFE24	24" low voltage fixture extension
LVFE36	36" low voltage fixture extension
LVFE48	48" low voltage fixture extension

Power Feeds and Connectors

H1LE	End feed
H1LEC	End feed with outlet box cover
H1LEBX	Conduit end feed
H1FC	Floating canopy
H1IJ	Mini I joiner
H1ILP	Adjustable I or L connector/feed
H1TP	Adjustable T connector/feed
H1XP	X connector/feed
H1FLXJ	Flexible joiner
H1MP	Monopoint Canopy Adapter

Suspension

HSK100	Suspension canopy
HSK102	Wireway cover for suspension
SK100	Suspension stem coupling
SK101	Sloped ceiling suspension adaptor
SK106	6" suspension stem
SK112	12" suspension stem
SK118	18" suspension stem
SK124	24" suspension stem
SK136	36" suspension stem
SK148	48" suspension stem
H1CS048P	48" cable suspension w/ powerfeed
H1CS120P	120" cable suspension w/ powerfeed
HCS048	48" cable suspension
HCS120C	120" cable suspension w/ canopy

Accessories

CP1	Outlet box cover
H1EC	End cap

H1 Track System

Single Circuit
120V

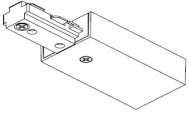
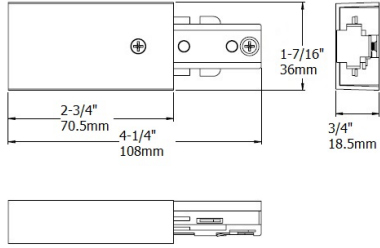
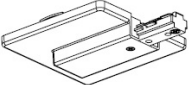
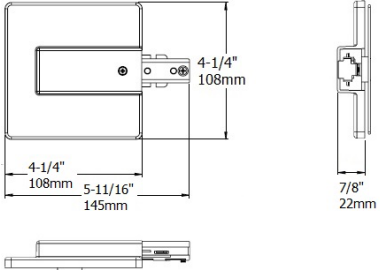
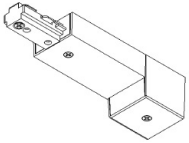
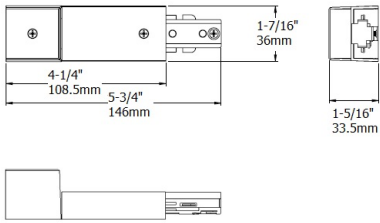
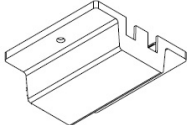
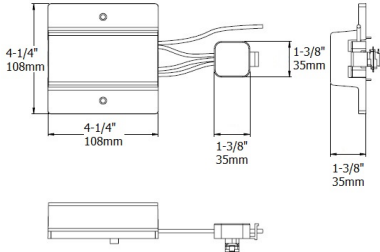
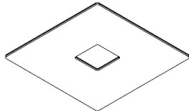
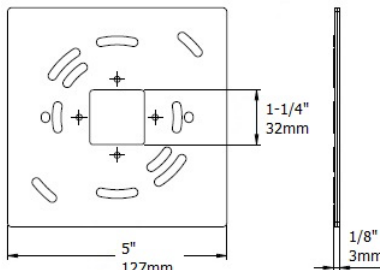

 <p>H1LE ■ ■ ■ End Feed</p>		<p>Direct wiring through ceiling with BX or end feed in suspension. CP1 (outlet box cover) required over junction box. Accepts 3/8" or 1/2" (trade size) electrical fittings. Reversed polarity available upon request.</p> <p>ORDERING INFORMATION</p> <table border="1"> <thead> <tr> <th>ITEM NO.</th> <th>FINISH</th> </tr> </thead> <tbody> <tr> <td>H1LE – End Feed</td> <td>-BK – Black</td> </tr> <tr> <td>H1LER – Reversed Polarity</td> <td>-WT – White</td> </tr> </tbody> </table> <table border="1"> <tr> <td>H1LE</td> <td>-</td> </tr> </table>	ITEM NO.	FINISH	H1LE – End Feed	-BK – Black	H1LER – Reversed Polarity	-WT – White	H1LE	-
ITEM NO.	FINISH									
H1LE – End Feed	-BK – Black									
H1LER – Reversed Polarity	-WT – White									
H1LE	-									
 <p>H1LEC ■ ■ ■ End Feed with Outlet Box Cover</p>		<p>Wiring through junction box. Built-in junction box cover. Reversed polarity available upon request.</p> <p>ORDERING INFORMATION</p> <table border="1"> <thead> <tr> <th>ITEM NO.</th> <th>FINISH</th> </tr> </thead> <tbody> <tr> <td>H1LEC – End Feed w/ Outlet Box Cover</td> <td>-BK – Black</td> </tr> <tr> <td>H1LECR – Reversed Polarity</td> <td>-WT – White</td> </tr> </tbody> </table> <table border="1"> <tr> <td>H1LEC</td> <td>-</td> </tr> </table>	ITEM NO.	FINISH	H1LEC – End Feed w/ Outlet Box Cover	-BK – Black	H1LECR – Reversed Polarity	-WT – White	H1LEC	-
ITEM NO.	FINISH									
H1LEC – End Feed w/ Outlet Box Cover	-BK – Black									
H1LECR – Reversed Polarity	-WT – White									
H1LEC	-									
 <p>H1LEBX ■ ■ ■ Conduit End Feed</p>		<p>Surface conduit wiring. Accepts 3/8" or 1/2" (trade size) electrical fittings. Reversed polarity available upon request. Combine standard and reversed polarity for a conduit continuity kit.</p> <p>ORDERING INFORMATION</p> <table border="1"> <thead> <tr> <th>ITEM NO.</th> <th>FINISH</th> </tr> </thead> <tbody> <tr> <td>H1LEBX – Conduit End Feed</td> <td>-BK – Black</td> </tr> <tr> <td>H1LEBXR – Reversed Polarity</td> <td>-WT – White</td> </tr> </tbody> </table> <table border="1"> <tr> <td>H1LEBX</td> <td>-</td> </tr> </table>	ITEM NO.	FINISH	H1LEBX – Conduit End Feed	-BK – Black	H1LEBXR – Reversed Polarity	-WT – White	H1LEBX	-
ITEM NO.	FINISH									
H1LEBX – Conduit End Feed	-BK – Black									
H1LEBXR – Reversed Polarity	-WT – White									
H1LEBX	-									
 <p>H1FC ■ ■ ■ Floating Canopy</p>		<p>Wiring through junction box. Can be located anywhere along track. Comes with one H1EC (end cap).</p> <p>ORDERING INFORMATION</p> <table border="1"> <thead> <tr> <th>ITEM NO.</th> <th>FINISH</th> </tr> </thead> <tbody> <tr> <td>H1FC – Floating Canopy</td> <td>-BK – Black</td> </tr> <tr> <td></td> <td>-WT – White</td> </tr> </tbody> </table> <table border="1"> <tr> <td>H1FC</td> <td>-</td> </tr> </table>	ITEM NO.	FINISH	H1FC – Floating Canopy	-BK – Black		-WT – White	H1FC	-
ITEM NO.	FINISH									
H1FC – Floating Canopy	-BK – Black									
	-WT – White									
H1FC	-									
 <p>CP1 ■ ■ ■ Outlet Box Cover</p>		<p>Covers 4" junction box at feed point.</p> <p>ORDERING INFORMATION</p> <table border="1"> <thead> <tr> <th>ITEM NO.</th> <th>FINISH</th> </tr> </thead> <tbody> <tr> <td>CP1 – Outlet box cover</td> <td>-BK – Black</td> </tr> <tr> <td></td> <td>-WT – White</td> </tr> </tbody> </table> <table border="1"> <tr> <td>CP1</td> <td>-</td> </tr> </table>	ITEM NO.	FINISH	CP1 – Outlet box cover	-BK – Black		-WT – White	CP1	-
ITEM NO.	FINISH									
CP1 – Outlet box cover	-BK – Black									
	-WT – White									
CP1	-									

H1 Track System

Single Circuit
120V

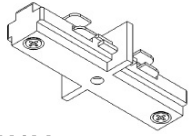

H1IJ

Mini I Joiner

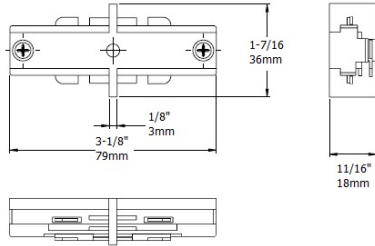

Connects two track sections. Low profile design for a clean continuous run.

ORDERING INFORMATION

ITEM NO.	FINISH
H1IJ – Mini I Joiner	-BK – Black -WT – White
H1IJ	-

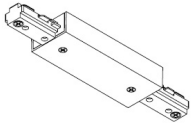

H1ILP

Adjustable I or L Connector/Feed

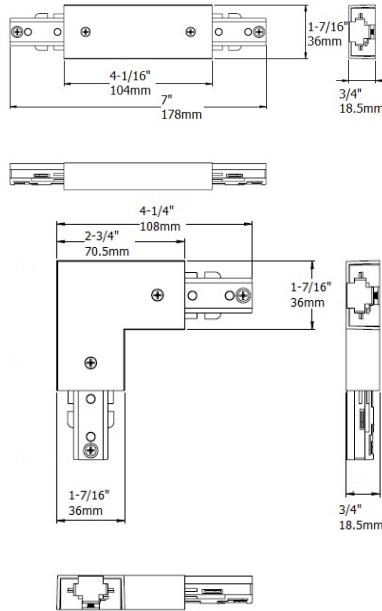

Connects two track sections in a straight or 90° configuration. Ships with 90° cover installed, straight cover included. May be used as feed point. **CP1** (outlet box cover) required over junction box.

ORDERING INFORMATION

ITEM NO.	FINISH
H1ILP – I or L Connector/Feed	-BK – Black -WT – White
H1ILP	-

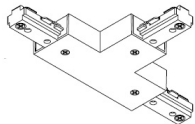

H11TP

Adjustable T Connector/Feed

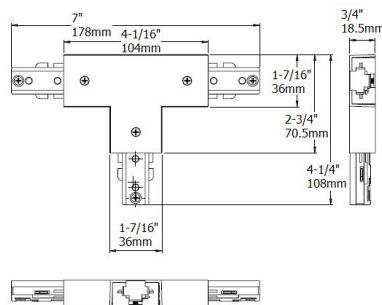

Connects three track sections in a T configuration. Adjustable for right or left application. May be used as feed point. **CP1** (outlet box cover) required over junction box.

ORDERING INFORMATION

ITEM NO.	FINISH
H11TP – T Connector/Feed	-BK – Black -WT – White
H11TP	-

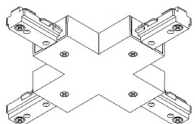

H11XP

X Connector/Feed

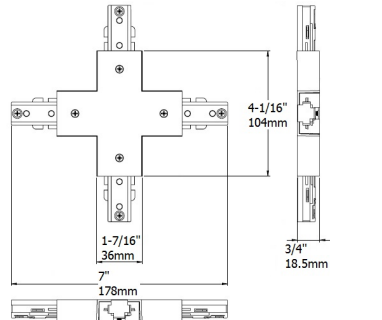

Connects four track sections in an X configuration. Factory wired for two separate 90° runs. May be field wired for one run. May be used as feed point. **CP1** (outlet box cover) required over junction box.

ORDERING INFORMATION

ITEM NO.	FINISH
H11XP – X Connector/Feed	-BK – Black -WT – White
H11XP	-

H1 Track System

Single Circuit
120V

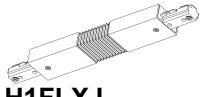

H1FLXJ
Flexible Joiner

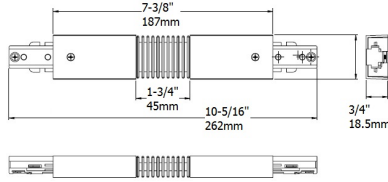

Connects two track sections up to 90° left, right, up or down.

ORDERING INFORMATION

ITEM NO.	FINISH
H1FLXJ – Flexible Joiner	-BK – Black -WT – White
H1FLXJ	-

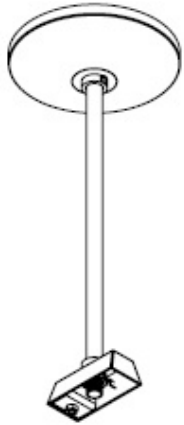

HSK100
Suspension Canopy

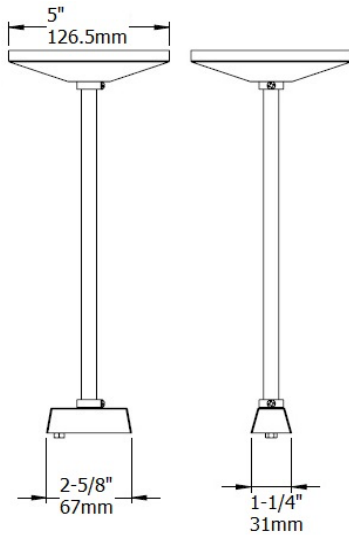

Suspend track from ceiling or junction box. Includes canopy and track bracket. Stem not included. Suspension stem in 6", 12", 18", 24", 36" and 48" are available to be ordered separately. Stem may be extended in any combination using **SK100** (suspension stem coupling).

For sloped ceiling application, add **SK101** (sloped ceiling suspension adaptor). One required per suspension canopy.

For electrical feed, add **HSK102** (wireway cover for suspension). One required per **H1LE** (end feed).

Use 2 per **H1TR2** (2' track) or **H1TR4** (4' track).
Use 3 per **H1TR6** (6' track) or **H1TR8** (8' track).

ORDERING INFORMATION

ITEM NO.	FINISH
HSK100 – Suspension Canopy	-BK – Black -WT – White
HSK100	-



SK1
Suspension Stem

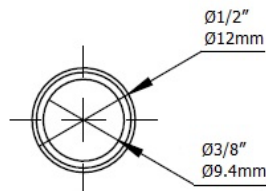

Suspend track from ceiling or junction box. Includes stem only. One required per **HSK100** (suspension canopy).

Available in 6", 12", 18", 24", 36" and 48". Stem may be extended in any combination using **SK100** (suspension stem coupling).

Use 2 per **H1TR2** (2' track) or **H1TR4** (4' track).
Use 3 per **H1TR6** (6' track) or **H1TR8** (8' track).

ORDERING INFORMATION

ITEM NO.	LENGTH	FINISH
SK1	06 – 6" Suspension Stem	-BK – Black
	12 – 12" Suspension Stem	-WT – White
	18 – 18" Suspension Stem	
	24 – 24" Suspension Stem	
	36 – 36" Suspension Stem	
	48 – 48" Suspension Stem	

SK1	-
------------	---

H1 Track System

Single Circuit
120V

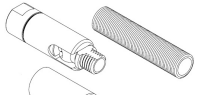

SK101
Sloped Ceiling Suspension Adaptor

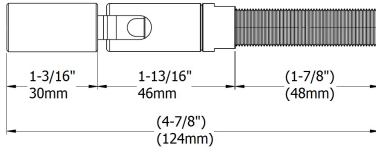

Suspend track from sloped ceiling. Use in conjunction with **HSK100** (suspension canopy). May be used to feed electrical wire up to 60° angle.

ORDERING INFORMATION

ITEM NO.	FINISH
SK101 – Sloped Ceiling Adaptor	-BK – Black -WT – White
SK101	-

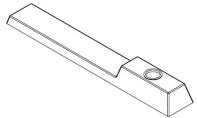

HSK102
Wireway Cover for Suspension

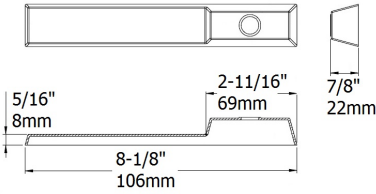

Conceals electrical feed wire from stem to **H1LE** (end feed). One required per **H1LE** (end feed).

ORDERING INFORMATION

ITEM NO.	FINISH
HSK102 – Wireway Cover	-BK – Black -WT – White
HSK102	-

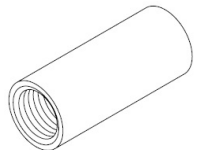

SK100
Suspension Stem Coupling

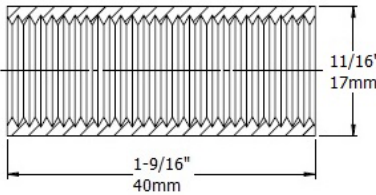

Connects two suspension stems to extend the drop. Suspension stem in 6", 12", 18" 24", 36" and 48" may be extended in any combination.

ORDERING INFORMATION

ITEM NO.	FINISH
SK100 – Suspension Stem Coupling	-BK – Black -WT – White
SK100	-

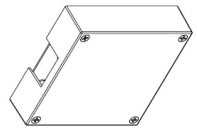

H1TBH
T-Bar Outlet Box Housing

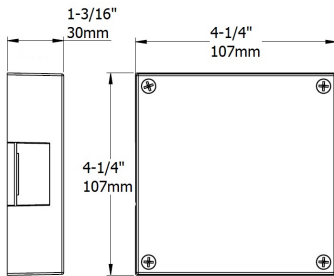

Direct wiring through ceiling tile with BX when T-Bar is directly above track. Accepts 3/8" or 1/2" (trade size) electrical fittings. Requires **H1LE**, **H1ILP**, **H1TP** or **H1XP**.

ORDERING INFORMATION

ITEM NO.	FINISH
H1TBH – T-Bar Outlet Box Housing	-WT – White
H1TBH	-WT

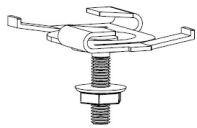

TBC
T-Bar Attachment Clip

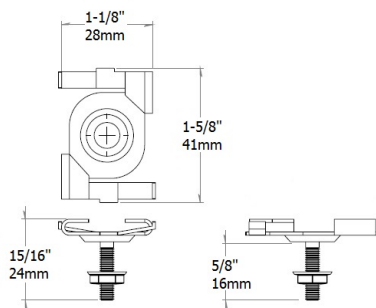

Twists on to T-grid for fast, easy and secure installation. Fits 15/16" T-grid. Supports up to 25-lbs static load.

Use 2 per **H1TR2** (2' track) or **H1TR4** (4' track).
Use 3 per **H1TR6** (6' track) or **H1TR8** (8' track).

ORDERING INFORMATION

ITEM NO.
TBC – T-Bar Attachment Clip
TBC



H1 Track System

Single Circuit
120V

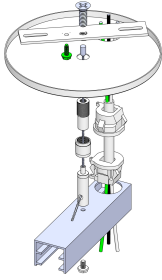

H1CSxxxP

Cable Suspension
w/ Powerfeed

Suspend track from junction box where powerfeed is needed. Includes canopy, 1/16" galvanized cable, 12/3 SJT cord, strain relieve and 4" cable ties.

Two-piece cable coupler design allows access to junction box without dropping the track. Length is easily adjustable using gripper w/ side exit on bottom end.

One required per **H1LE** (end feed).

Use in conjunction with **HCS048** (cable suspension) or **HCS120C** (cable suspension with canopy).

ORDERING INFORMATION

ITEM NO.	FINISH
H1CS048P – 48" cable suspension w/ powerfeed	-BK – Black -WT – White
H1CS120P – 120" cable suspension w/ powerfeed	

H1CSxxxP	-
-----------------	---

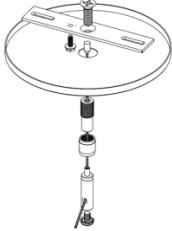

HCS120C

Cable Suspension
With Canopy

Suspend track from Junction box. Included canopy, and 1/16" galvanized cable

Two-piece cable coupler design allows access to junction box without dropping the track. Length is easily adjustable using gripper w/ side exit on bottom end.

Use 2 per **H1TR2** (2' track) or **H1TR4** (4' track).

Use 3 per **H1TR6** (6' track) or **H1TR8** (8' track).

Use **H1CS048P** or **H1CS120P** (cable suspension w/ powerfeed) where powerfeed is needed.

ORDERING INFORMATION

ITEM NO.	FINISH
HCS120C – 120" cable suspension w/ Canopy	-BK – Black -WT – White

HCS120C	-
----------------	---

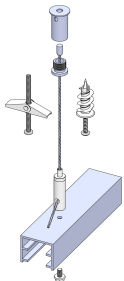

HCS048

Cable Suspension

Suspend track from ceiling. Includes plastic self drilling drywall anchor, #1/8 toggle wing, 1/16" galvanized cable.

Two-piece standoff provides easy installation and minimal footprint of only 5/8". Length is easily adjustable using gripper w/ side exit on bottom end.

Use 2 per **H1TR2** (2' track) or **H1TR4** (4' track).

Use 3 per **H1TR6** (6' track) or **H1TR8** (8' track).

Use **H1CS048P** (cable suspension w/ powerfeed) where powerfeed is needed.

ORDERING INFORMATION

ITEM NO.
HCS048 – 48" cable suspension

HCS048

H1 Track System

Single Circuit
120V

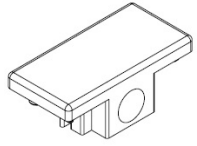

H1EC
■ ■ ■
End Cap

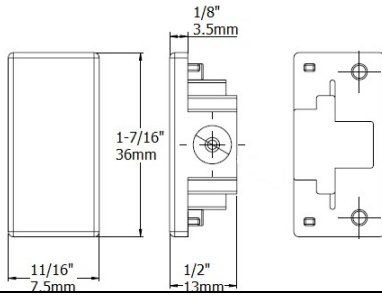

Covers end of track section. One included with each **H1TR** (H1 Track)

ORDERING INFORMATION

ITEM NO.	FINISH
H1EC – End cap	-BK – Black -WT – White
H1EC	-



H2HVFE
■ ■ ■
Line Voltage
Fixture Extension

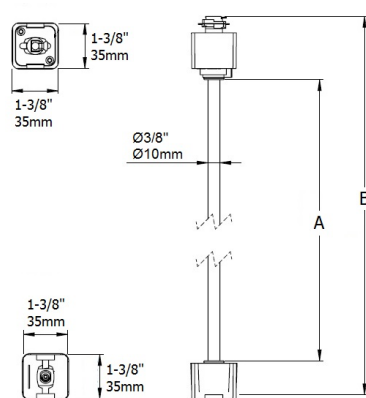

Extends line voltage fixture from track. For use with **H1TR** (JESCO H1 track).

ORDERING INFORMATION

ITEM NO.	LENGTH	FINISH
H2HVFE – Line voltage fixture extension	12 – A=12\"/>	
H2HVFE	-	



LVFE
■ ■ ■
Low Voltage
Fixture Extension

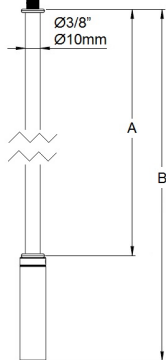

Extends low voltage fixture lamp housing from transformer housing. Factory assembled.

ORDERING INFORMATION

ITEM NO.	LENGTH	FINISH
LVFE – Low voltage fixture extension	06 – A=6\"/>	
LVFE	-	

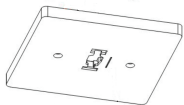

H1MP
■ ■ ■
Monopoint
Canopy

Mounts a single track fixture to a recessed junction box.

ORDERING INFORMATION

ITEM NO.	FINISH
H1MP – Monopoint Canopy	-BK – Black -WT – White
H1MP	-